



- Tentative Specification
- Preliminary Specification
- Approval Specification

MODEL NAME: PV101029S0140X

Customer: Common	
APPROVED BY	SIGNATURE
Name / Title _____	_____
Note	

Approved By	Checked By	Prepared By



REVISION HISTORY

Version	Date	Page	Description
V1.0	2021/08/11	ALL	First issue



Contents

1. General Specifications	4
2. Pin Assignment	5
3. Operation Specifications	8
3.1. Absolute Maximum Ratings	8
3.1.1. Typical Operation Conditions.....	8
3.1.2. Current Consumption	9
3.1.3. Backlight Driving Conditions.....	9
3.2. Power Sequence	10
3.3. Timing Characteristics	11
3.3.1. AC Electrical Characteristics	11
3.3.2. Input Clock and Data Timing Diagram	12
3.3.3. DC Electrical Characteristics	13
3.3.4. Timing.....	14
3.3.5. Data Input Format.....	14
3.3.6. Reset timing.....	15
4. Optical Specifications	16
5. Reliability Test Items	20
6. General Precautions	22
6.1. Safety.....	22
6.2. Handling	22
6.3. Static Electricity	22
6.4. Storage.....	22
6.5. Cleaning	23
7. Mechanical Drawing	24
8. Package Drawing	25
9. DEFINITION OF LABELS	26



1. General Specifications

No.	Item	Specification	Remark
1	LCD size	10.1 inch (Diagonal)	
2	Driver element	a-Si TFT active matrix	
3	Resolution	1280 × 3(RGB) × 720	
4	Display mode	Normally Black, Transmissive	
5	Dot pitch	0.17475(W) × 0.17475(H) mm	
6	Active area	223.68(W) × 125.82(H) mm	
7	Module size	238.60(W) × 148.00(H) × 6.5(D) mm	Note 1
8	Surface treatment	Anti-Glare	
9	Color arrangement	RGB-stripe	
10	Interface	1-port LVDS (DE mode only)	
11	Backlight power consumption	7.84W (Max.)	
12	Panel power consumption	1.6W (Max.)	
13	Weight	330 g (Typ.)	
14	NTSC	70%	

Note 1: Refer to Mechanical Drawing.



2. Pin Assignment

PCBa connector is used for the module electronics interface. The recommended model is 20647-040E-01 manufactured by I-PEX.

Pin No.	Symbol	I/O	Pulled Internally (Note3)	Function	Remark
1	NC	--		Keep floating	
2	VDD	P	High	External main and I/O power supply ; Power3V3	Note 2
3	VDD	P	High	External main and I/O power supply : Power3V3	Note 2
4	NC	--		Keep floating	
5	RESET	I	High	Global reset pin	Note 2
6	STBYB	I	High	Standby mode setting pin	Note 2
7	GND	P	Low	Ground	
8	RXIN0-	I		LVDS data 0-	
9	RXIN0+	I		LVDS data 0+	
10	GND	P	Low	Ground	
11	RXIN01-	I		LVDS data 1-	
12	RXIN01+	I		LVDS data 1+	
13	GND	P	Low	Ground	
14	RXCLKIN-	I		LVDS clk -	
15	RXCLKIN+	I		LVDS clk +	
16	GND	P	Low	Ground	
17	RXIN02-	I		LVDS data 2-	
18	RXIN02+	I		LVDS data 2+	
19	GND	P	Low	Ground	
20	RXIN03-	Input		LVDS data 3-	
21	RXIN03+	Input		LVDS data 3+	
22	GND	Power	Low	Ground	
23	SCL	I		Serial interface clock input for 3 wire SPI interface. IF not used, please keep floating.	
24	SDA	I/O		Serial interface address and data input/output for 3 wire SPI interface. IF not used, please keep floating	



25	GND	P	Low	Ground	
26	CSB	I		Serial interface enable input for 3 wire SPI interface. IF not used, please keep floating.	
27	NTC_GND	-		LED Driver for NTC Function, If not use please keep floating	
28	SELB(DINT)	I	High	Input Input data format selection DINT = 1 : 8-bit (Default) DINT = 0 : 6-bit	
29	NC	-		Keep floating	
30	GND	P	Low	Ground	
31	LED-	P		Negative backlight voltage	
32	LED-	P		Negative backlight voltage	
33	L/R	I	High	Horizontal shift direction (source output) selection. RL = 1: Left -> Right (Default) RL = 0: Right -> Left	
34	U/D	I	High	Vertical shift direction (gate output) selection. TB = 1: Top ->Bottom (Default) TB = 0: Bottom ->Top	
35	NTC	I		LED Driver for NTC Function, If not use please keep floating	
36	NC	-		Keep floating	
37	VDD_OTP	I		LCD Maker use, please keep floating	
38	NC	-		Keep floating	
39	LED+	P		Positive backlight voltage	
40	LED+	P		Positive backlight voltage	

Note 2: Please follow Item 3.1 and 3.2.

Note 3: Typical internal pull low / high resistor is 350 kΩ.

Note 4: Definition of scanning direction.
Refer to the figure as below:



Note 4: Definition of scanning direction.
Refer to the figure as below:

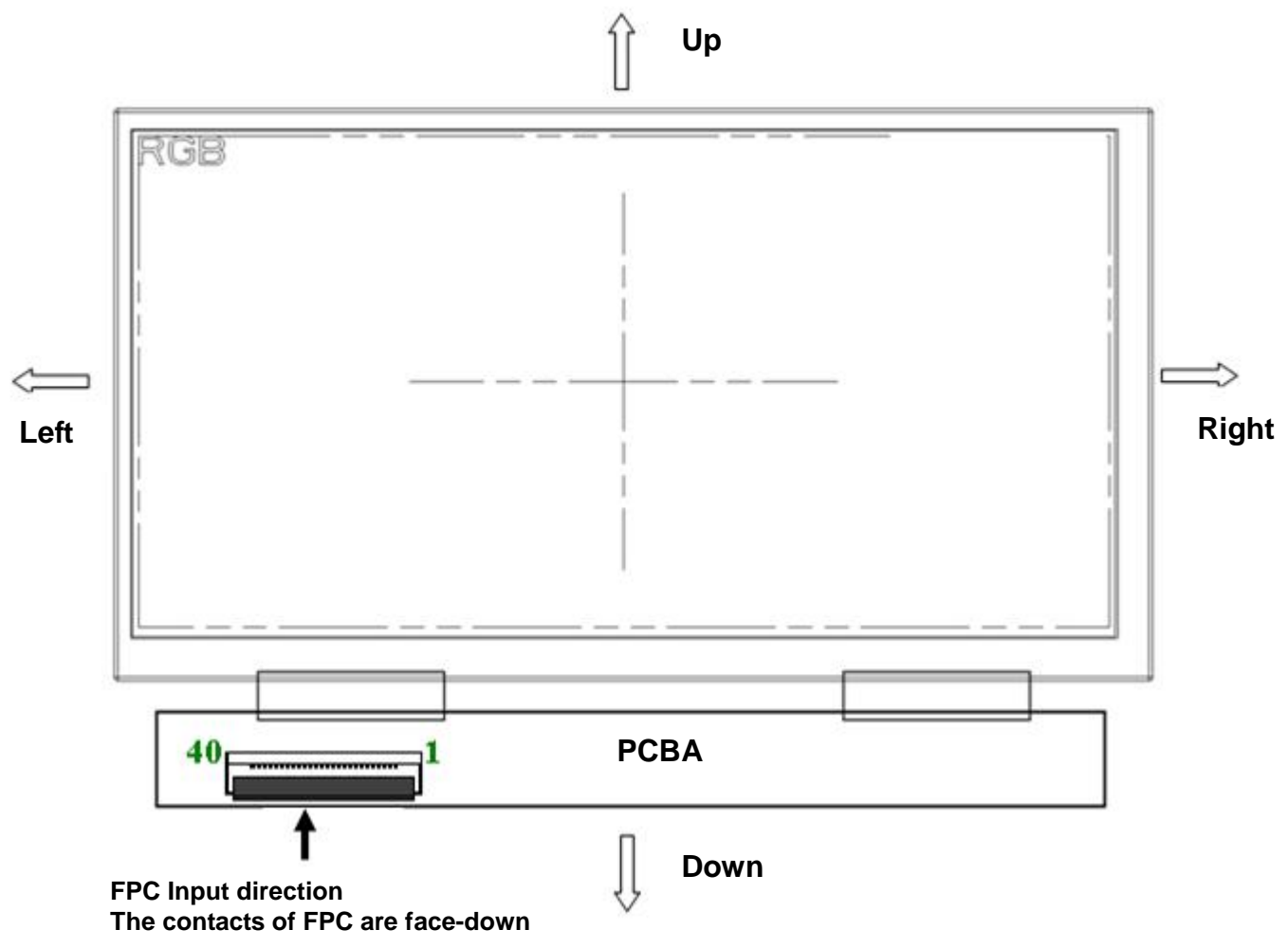



3. Operation Specifications

3.1. Absolute Maximum Ratings

(GND=0V, Note 5)

Item	Symbol	Values		Unit	Remark
		Min.	Max.		
Power voltage	V_{DD}	-0.3	3.96	V	
Operation Temperature	T_{OP}	-30	85	°C	
Storage Temperature	T_{ST}	-40	90	°C	
LED Reverse Voltage	VR	-	-	V	Note 2
LED Forward Current	IF	-	150	mA	Each LED

Note 1: The absolute maximum rating values of this product are not allowed to be exceeded at any times. Should a module be used with any of the absolute maximum ratings exceeded, the characteristics of the module may not be recovered, or in an extreme case, the module may be permanently destroyed.

Note 2: Do not reverse the connection of LED

3.1.1. Typical Operation Conditions

(GND =0V)

Item	Symbol	Values			Unit	Remark
		Min.	Typ.	Max.		
Power voltage	V_{DD}	3.0	3.3	3.6	V	Note 1
Input logic high voltage	V_{IH}	$0.7 V_{DD}$	-	V_{DD}	V	Note 2
Input logic low voltage	V_{IL}	GND	-	$0.3 V_{DD}$	V	
Internal Pull low / high resistor	RI	200	350	850	kΩ	Note 2

Note 1: V_{DD} setting should match the signals output voltage of customer's system board .

Note 2: RESET, STBYB, SELB(DINT), L/R, U/D



3.1.2. Current Consumption

Item	Symbol	Values			Unit	Remark
		Min.	Typ.	Max.		
Current for Driver	I_{DD}		320		mA	$V_{DD} = 3.3V$

3.1.3. Backlight Driving Conditions

Item	Symbol	Values			Unit	Remark
		Min.	Typ.	Max.		
Voltage for LED backlight	V_L	21.6	-	27.2	V	Note 1
Current for LED backlight	I_L		288		mA	
LED life time	-	20,000			Hr	Note 2

Note 1: The LED Supply Voltage is defined by the number of LED at $T_a=25^{\circ}C$ and $I_L = 320mA$

Note 2: The “LED life time” is defined as the module brightness decrease to 50% original brightness at

$T_a=25^{\circ}C$ and $I_L = 320mA$. The LED lifetime could be decreased if operating I_L is larger than 320mA.



3.2. Power Sequence

VDD = 3.0~3.6V

a. Power on:

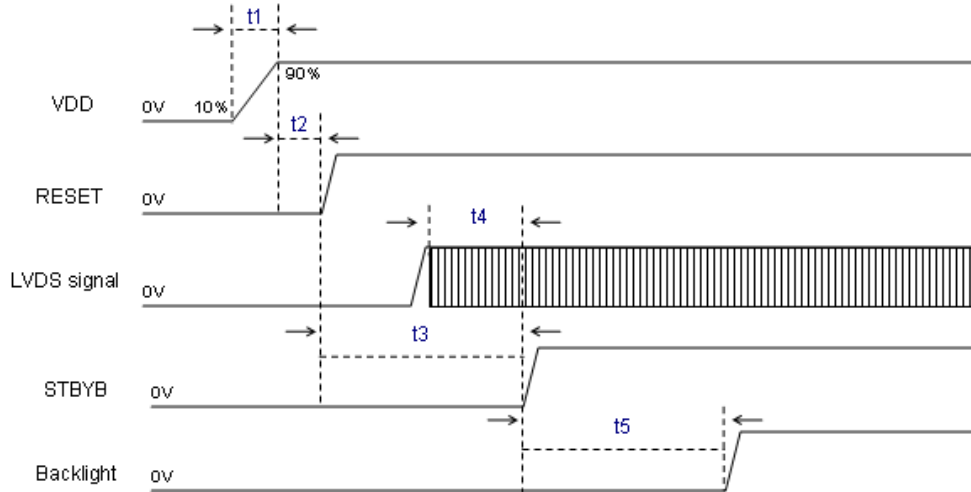

b. Power off:

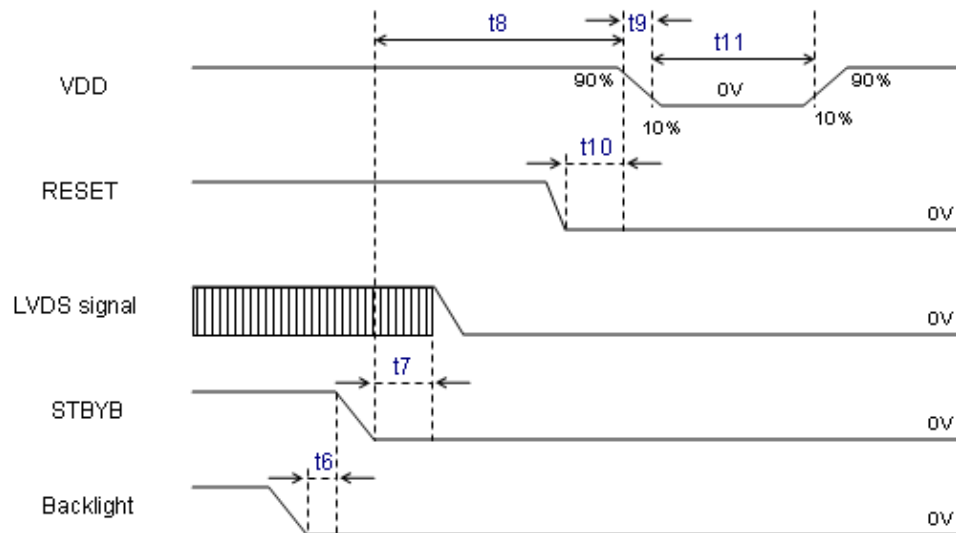

Symbol	SPEC.			Unit
	Min.	Typ.	Max.	
t1	0.5	5	10	ms
t2	30	40	50	us
t3	10	15	20	ms
t4	1	5	t3	ms
t5	118	119	t6	ms
t6	120	128	135	ms
t7	0.5	5	10	ms
t8	0	5	10	ms
t9	500	650	800	ms



3.3. Timing Characteristics

3.3.1. AC Electrical Characteristics

Parameter	Symbol	Spec.			Unit	Remark
		Min.	Typ.	Max.		
Clock frequency	FLVCYC	10	-	85	MHz	Frame rate=60Hz
Clock Period	TLVCYC	11.76	-	100	Nsec	Frame rate=60Hz
1 data bit time	UI	-	1/7	-	TLVCYC	
Position 1	TPOS1	-0.2	0	0.2	UI	Note 1
Position 0	TPOS0	0.8	1	1.2	UI	
Position 6	TPOS6	1.8	2	2.2	UI	
Position 5	TPOS5	2.8	3	3.2	UI	
Position 4	TPOS4	3.8	4	4.2	UI	
Position 3	TPOS3	4.8	5	5.2	UI	
Position 2	TPOS2	5.8	6	6.2	UI	
Input eye width	TEYEW	0.6	-	-	UI	
Input eye border	TEX	-	-	0.2	UI	
LVDS wake up time	TENLVDS	-	-	150	ns	

Note 1: Please refer to “3.3.2. Input Clock and Data Timing Diagram”



3.3.2. Input Clock and Data Timing Diagram

LVDS input timing:

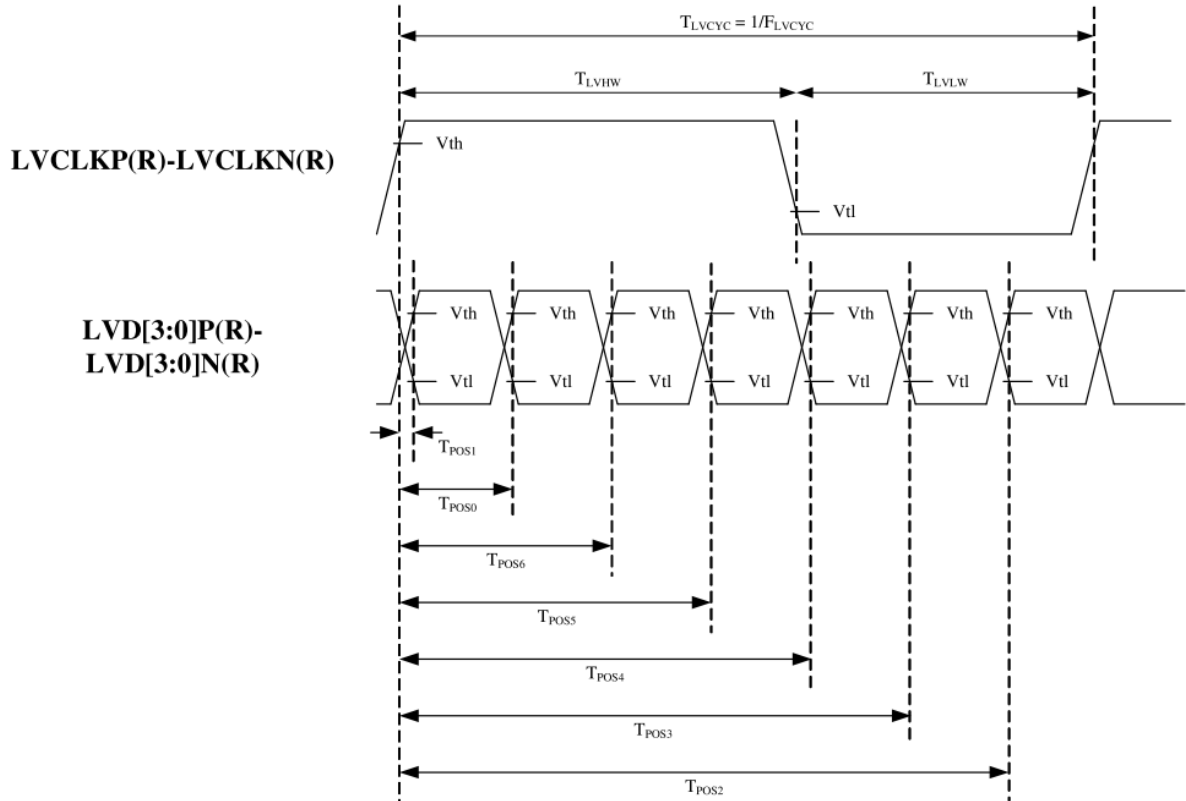

Differential:

LVD[3:0]P-LVD[3:0]N

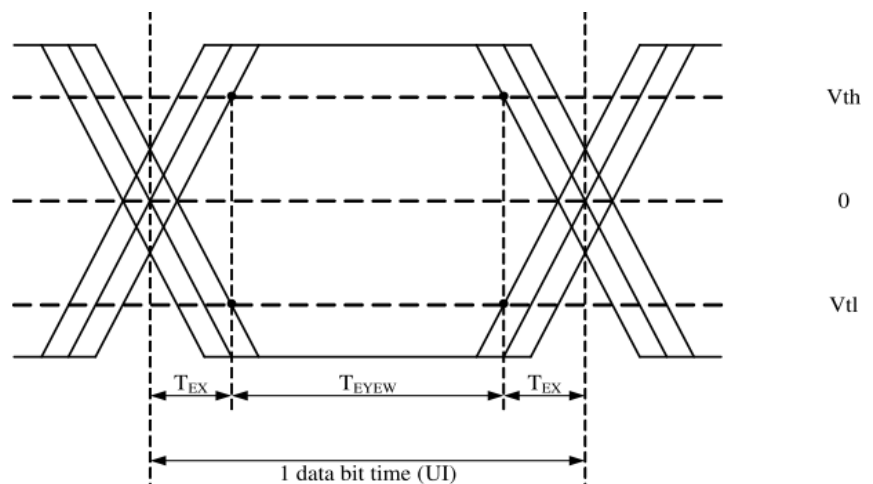

LVDS input eye diagram



3.3.3. DC Electrical Characteristics

Parameter	Symbol	Spec.			Unit	Remark
		Min.	Typ.	Max.		
Differential input high Threshold voltage	Vth	-	-	+0.1	V	Vcm=1.2V
Differential input low Threshold voltage	Vtl	-0.1	-	-	V	
Differential input common Mode voltage	Vcm	1	1.2	1.8- V _{id} /2	V	-
LVDS input voltage	V _{INLV}	0.7		1.8	V	
Differential input voltage	V _{id}	0.2	-	0.6	V	-
Differential input leakage Current	Vleak	-10	-	+10	μA	-
Termination Resistor	Z _{id}	80	100	120	Ω	-

Differential:
 LVCLKP(R)-LVCLKN(R),
 LVD[3:0]P(R)-
 LVD[3:0]N(R)

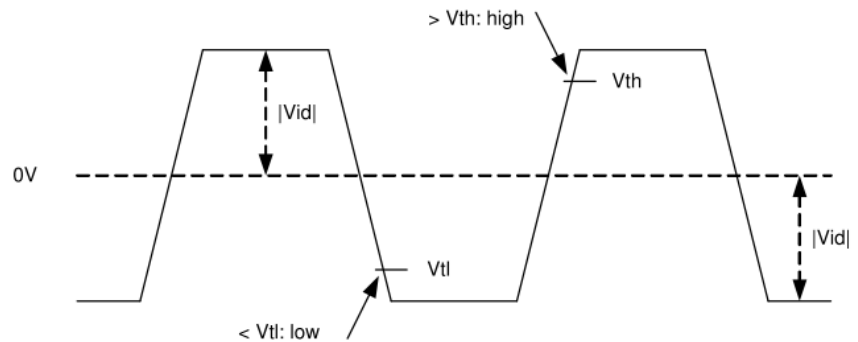



3.3.4. Timing

Parameter	Symbol	Values			Unit	Remark
		Min.	Typ.	Max.		
DCLK Frequency	F DCLK	58.5	63.7	76.3	MHz	Frame rate=60Hz
Horizontal valid data	t hd	1280			DCLK	
H-blanking	t hb	56	60	192	DCLK	
1 Horizontal Line	t h	1336	1340	1472	DCLK	
Vertical valid data	t vd	720			H	
V-blanking	t vb	10	72	144	H	
1 Vertical field	t v	730	792	864	H	

Note : DE mode only.

3.3.5. Data Input Format

LVDS, 6-bit:

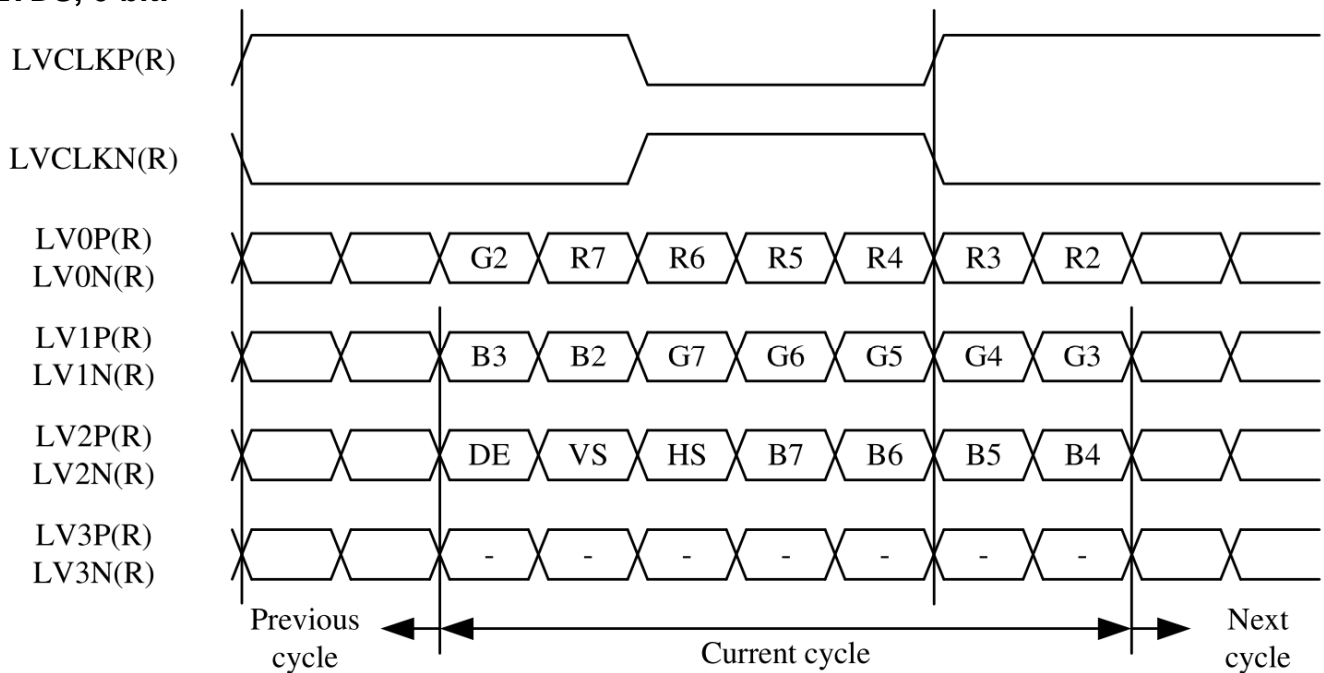



LVDS, 8-bit, VESA format:

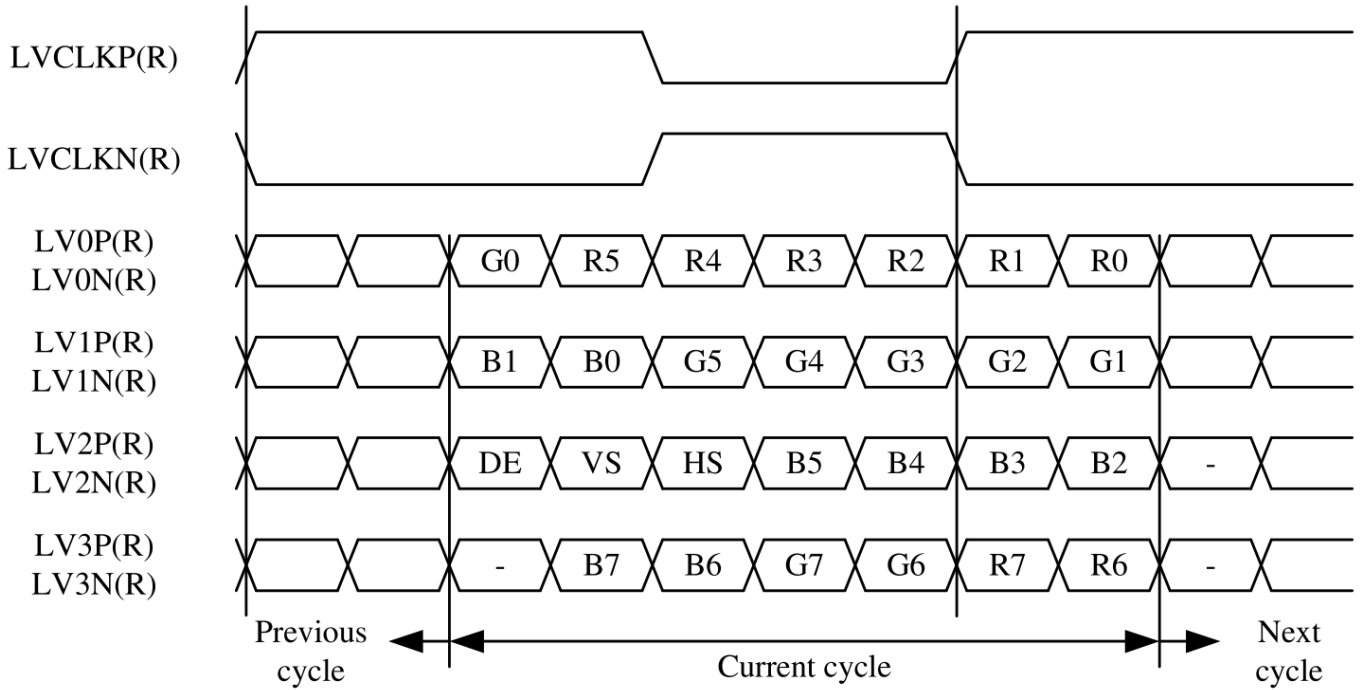

3.3.6. Reset timing

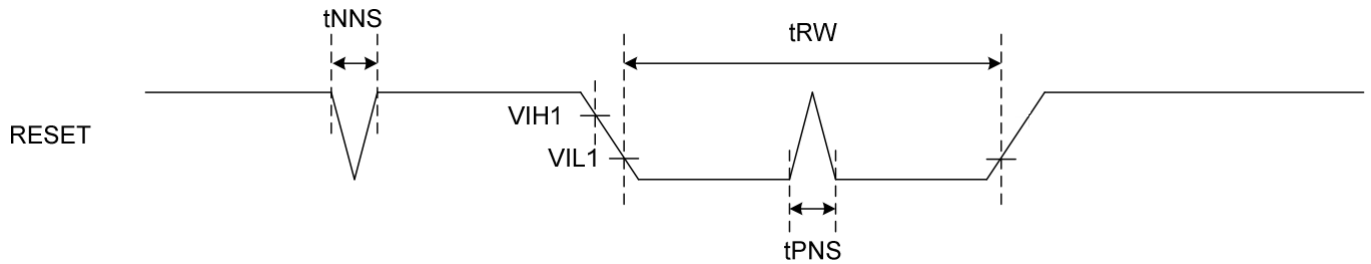

(VDD=3.3V ~ 3.6V)

Signal	Parameter	Symbol	Spec.			Unit	Remark
			Min.	Typ.	Max.		
RESET	Reset pulse width	tRW	10	-	-	μs	-
	Positive spike noise width	tPNS	-	-	100	ns	-
	Negative spike noise width	tNNS	-	-	100	ns	-



4. Optical Specifications

Item	Symbol	Condition	Values			Unit	Remark
			Min.	Typ.	Max.		
Viewing angle (CR≥ 10)	θ_L	$\Phi=180^\circ$ (9 o'clock)		85	-	degree	Note 1
	θ_R	$\Phi=0^\circ$ (3 o'clock)		85	-		
	θ_T	$\Phi=90^\circ$ (12 o'clock)		85	-		
	θ_B	$\Phi=270^\circ$ (6 o'clock)		85	-		
Response time	T_{ON}	Normal $\theta=\Phi=0^\circ$	-	15	20	msec	Note 3
	T_{OFF}		-	10	15	msec	Note 3
Contrast ratio	CR		600	1000	-	-	Note 2 Note 4
Color chromaticity	W_X		0.25	0.30	0.35	-	Note 2 Note 5
	W_Y		0.26	0.31	0.36	-	
Luminance	L		600	750	-	cd/m ²	Note 6
Luminance uniformity	Y_U		75	80	-	%	Note 6

Test Conditions:

1. $DV_{DD}=3.3V$, $I_L=288mA$ (Backlight current), the ambient temperature is 25°C.
2. The test systems refer to Note 2



Note 1: Definition of viewing angle range
 The view angle for $\theta=85^\circ$ is measured by BM-5A

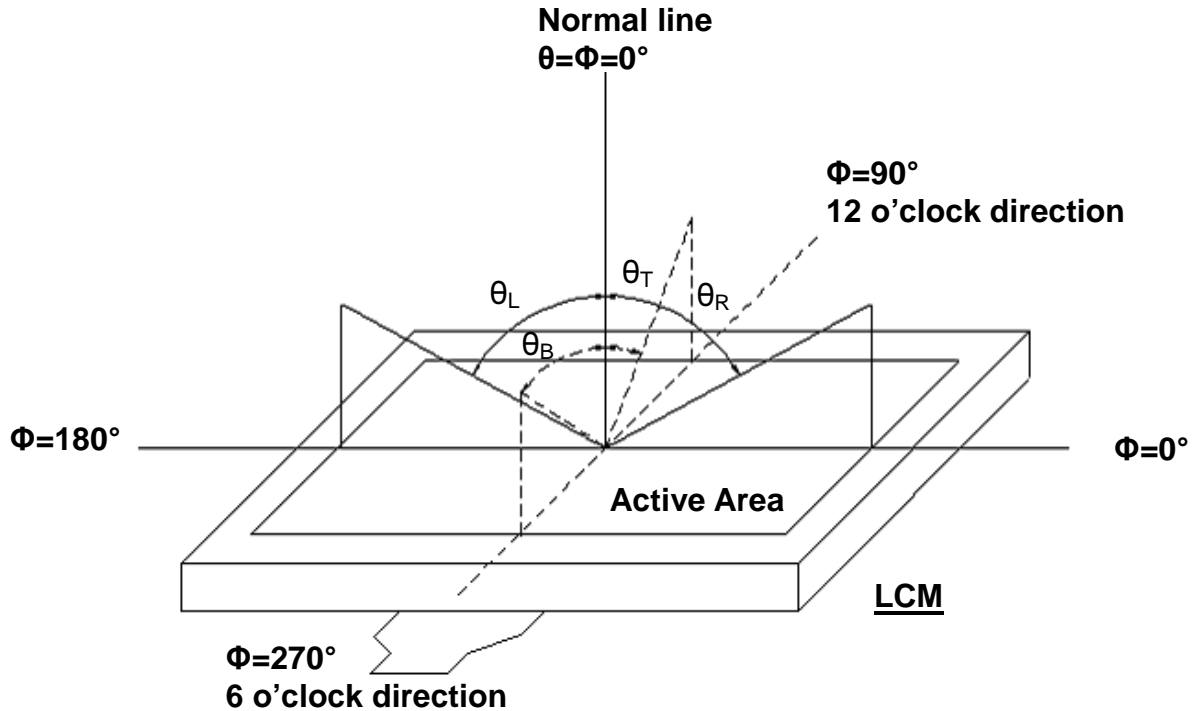

Fig. 4-1 Definition of viewing angle

Note 2: Definition of optical measurement system.
 The backlight has been light on for 30 minutes then measured the optical properties at the center point of the LCD screen in dark room. The color chromaticity, contrast ratio are measured by DMS 803.

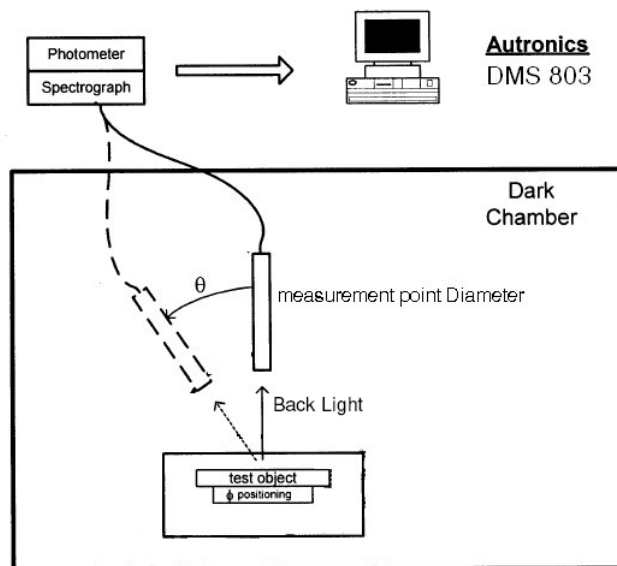

Fig. 4-2 Optical measurement system setup

**Note 3: Definition of Response time**

The response time is measured by photo detector of oscilloscope.

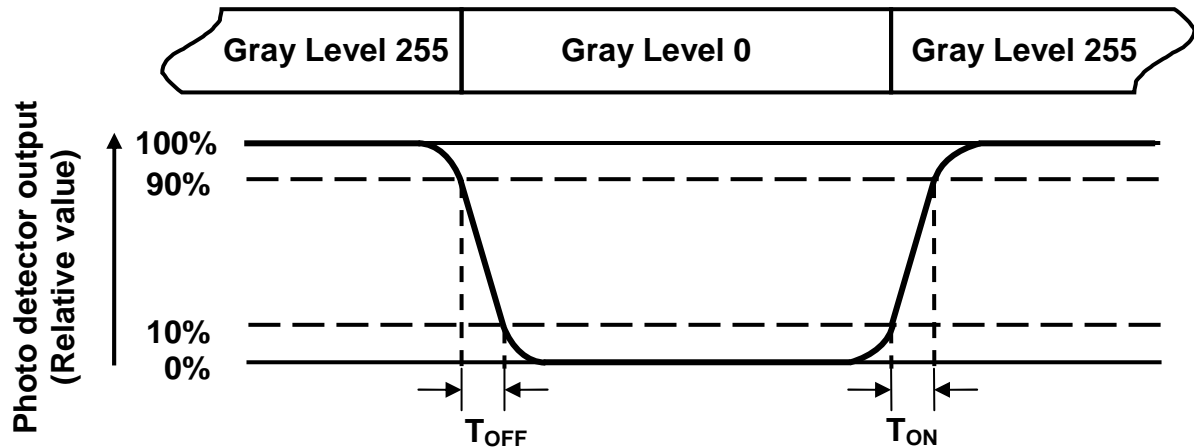

Fig. 4-3 Definition of response time

Note 4: Definition of contrast ratio

$$\text{Contrast ratio (CR)} = \frac{\text{Luminance measured when LCD on the "White" state}}{\text{Luminance measured when LCD on the "Black" state}}$$

Note 5: Definition of color chromaticity (CIE1931)

Color coordinates measured at center point of LCD.

Note 6: All input terminals LCD panel must be ground while measuring the center area of the panel. The LED driving condition is $I_L=288\text{mA}$.



Note 7: Definition of luminance uniformity

Active area is divided into 9 measuring areas (Refer to Fig. 4-4).

$$\text{Luminance Uniformity (Yu)} = \frac{B_{min}}{B_{max}}$$

L----- Active area length W----- Active area width

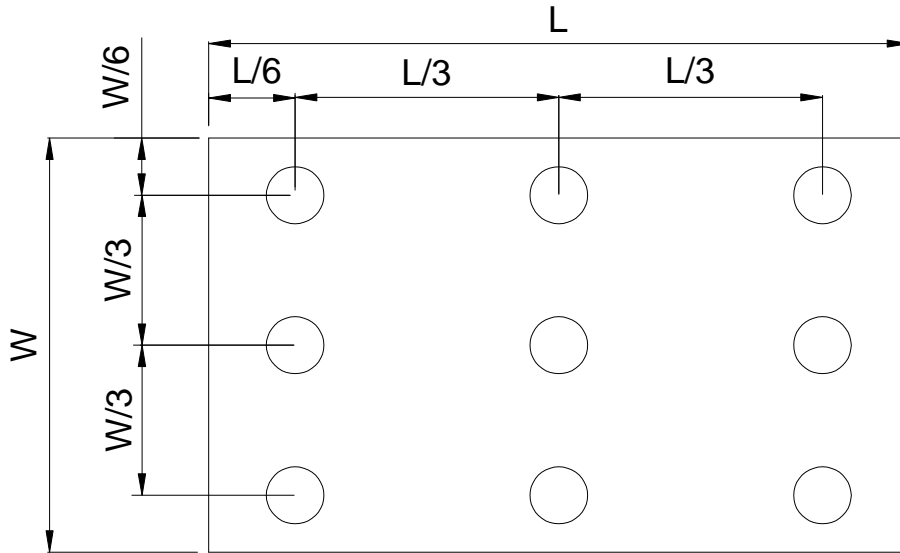

Fig. 4-4 Definition of measuring points

B_{max}: The measured maximum luminance of all measurement position.

B_{min}: The measured minimum luminance of all measurement position.



5. Reliability Test Items

Item	Test Conditions	Remark
High Temperature Storage Test	90°C, 500 hours	Note 1 Note 2 Note 4
Low Temperature Storage Test	-40°C, 500 hours	
High Temperature Operation Test	85°C, 500 hours	
Low Temperature Operation Test	-30°C, 500 hours	
High Temperature & High Humidity Operation Test	60°C, RH 90%, 500 hours	
Thermal Shock	[(-30°C 30min)→(85°C 30min)]/cycle , (Ramp rate≥20°C/min) , 100cycles	
ESD Test (Non-Operation)	Condition 1 : C = 150pF, R = 330Ω Contact Discharge, ± 8KV Condition 2 : C = 150pF, R = 330Ω, Air Discharge, ± 15KV	Note 1
ESD Test (Operation)	Condition 1 : C = 150pF, R = 330Ω Contact Discharge, ± 8KV Condition 2 : C = 150pF, R = 330Ω, Air Discharge, ± 15KV	Note 5
Mechanical Shock	100G, 6ms, half sine wave, 3 times for each direction of ±X, ±Y, ±Z	Note 1 Note 3
Mechanical Vibration	Frequency: 10 ~55~10Hz; Sweep Mode: Log Sweep Sweep time: 1Oct/min; Acceleration: 1.5G; Test time: 2 hr for each direction of X, Y, Z.	Note 1 Note 3
Packaging Vibration Test	1.47Grms X, Y, Z three axes (30min /axis) [Frequency : 5Hz(0.015G ² /Hz) , 100Hz(0.015G ² /Hz) , 200Hz(0.0037G ² /Hz)]	
Packaging Drop Test	1 corner, 3 edges, 6 faces (1 time/direction) <follow ISTA(1A) Height> 0kg≤W <10kg : 76cm, 10kg≤W <19kg : 61cm, 19kg≤W <28kg : 46cm, 28kg≤W <45kg : 31cm,	



Note 1: Criteria: Normal display image with no obvious non-uniformity and no line defect.

Note 2: Evaluation should be tested after storage at room temperature for more than two hour

Note 3: At testing Vibration and Shock, the fixture in holding the module has to be hard and rigid enough so that the module would not be twisted or bent by the fixture.

Note 4: A certain level of Mura (non-uniformity) of dark / black image will happen several days after high temperature testing (H.T.T.). There is a slowly part recovery over a long time (several months). Such a long exposure time like in H.T.T. will normally not happen in a real application. Therefore the test H.T.T. was introduced to simulate cycles with normal conditions in-between but with the same total exposure time what show a significant reduced Mura.

The root cause is related to tension generated due to different amount of shrinking in the stack of layers in the polarizer sheet. The effect is more significant on larger displays like this size. An investigation into alternative polarizer material showed that there is no better alternative currently available.

Note 5: Criteria Class B: Some performance degradation allowed. No data loss. Self - recoverable No hardware failures

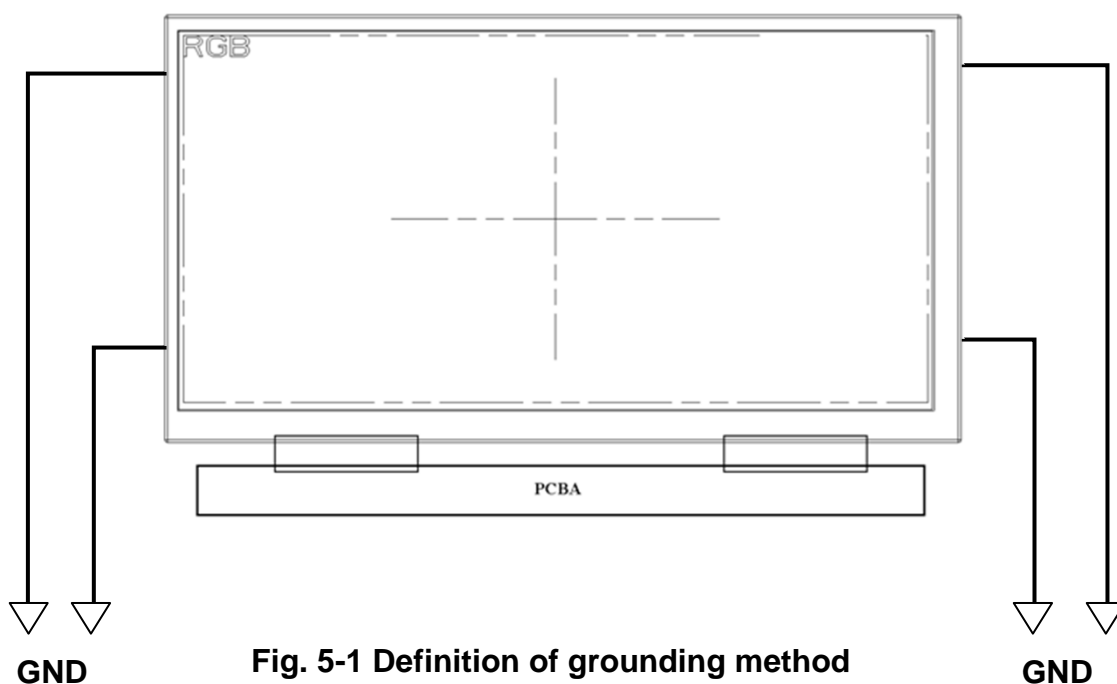

Fig. 5-1 Definition of grounding method



6. General Precautions

6.1. Safety

Liquid crystal is poisonous. Do not put it in your mouth. If liquid crystal touches your skin or cloths, wash it off immediately by using soap and water.

6.2. Handling

1. The LCD panel is plate glass. Do not subject the panel to mechanical shock or to excessive force on its surface.
2. The polarizer attached to the display is easily damaged. Please handle it carefully to avoid scratch or other damages.
3. To avoid contamination on the display surface, do not touch the module surface with bare hands.
4. Keep a space so that the LCD panels do not touch other components.
5. Put cover board such as acrylic board on the surface of LCD panel to protect panel from damages.
6. Transparent electrodes may be disconnected if you use the LCD panel under environmental conditions where the condensation of dew occurs.
7. Do not leave module in direct sunlight to avoid malfunction of the ICs.

6.3. Static Electricity

1. Be sure to ground module before turning on power or operating module.
2. Do not apply voltage which exceeds the absolute maximum rating value.

6.4. Storage

1. Store the module in a dark room where must keep at $25\pm 10^{\circ}\text{C}$ and 65%RH or less.
 2. Do not store the module in surroundings containing organic solvent or corrosive gas.
 3. Store the module in an anti-electrostatic container or bag.
-



6.5. Cleaning

- 1. Do not wipe the polarizer with dry cloth. It might cause scratch.**
 - 2. Only use a soft sloth with IPA to wipe the polarizer, other chemicals might permanent damage to the polarizer.**
-

客户承认

V0

初版图纸

2021.07.30

正视图

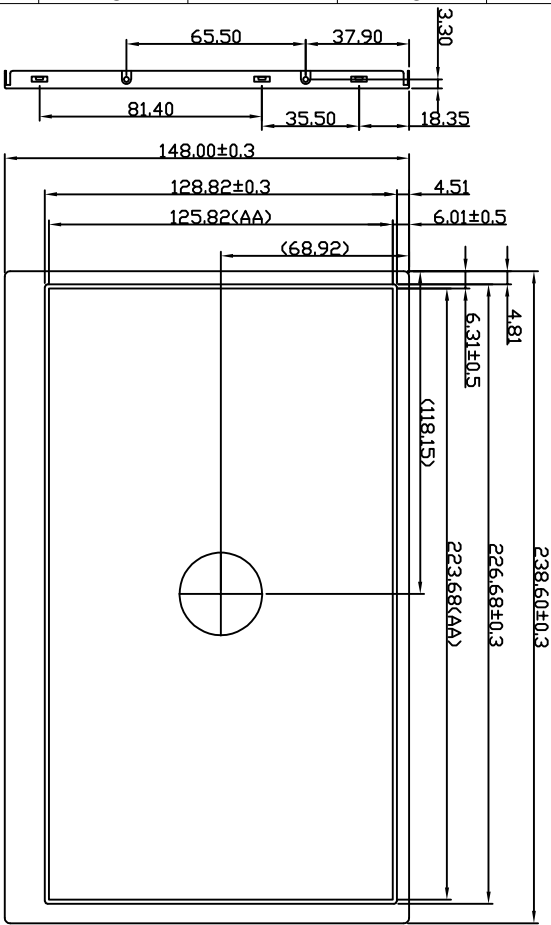

侧视图

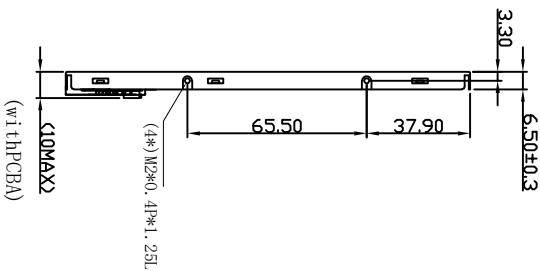

背视图

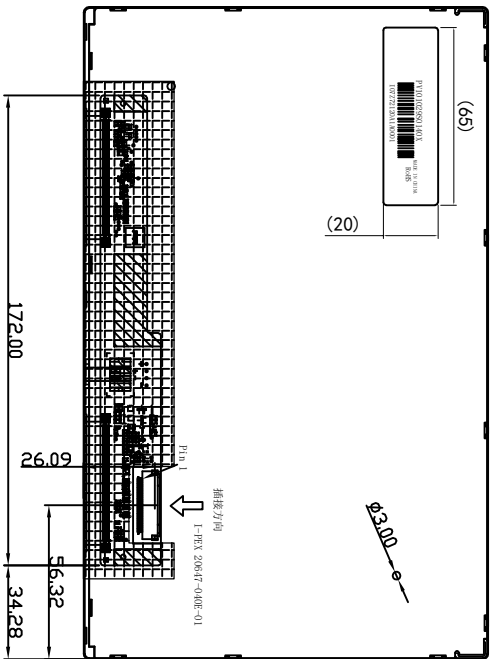

Pin#	Assignment
1	NC
2	VDD
3	VDD
4	NC
5	Reset
6	STBYB
7	GND
8	RXIND-
9	RXIND+
10	GND
11	RXIND-
12	RXIND+
13	GND
14	RXCLKIN-
15	RXCLKIN+
16	GND
17	RXIND2-
18	RXIND2+
19	GND
20	RXIND3-
21	RXIND3+
22	GND
23	NC
24	NC
25	GND
26	NC
27	NC
28	SEI(B,GND)
29	NC
30	GND
31	LED-
32	LED-
33	L/R
34	U/D
35	NC
36	NC
37	NC
38	NC
39	LED+
40	LED+

1. 单位: mm
2. 显示模式: 10.1" Color TFT, Normally Black
3. 驱动IC: //
4. 未注倒角: R0.3, 未注尺寸公差: ±0.3
5. “*” 重点管控尺寸; “()” 参考尺寸
6. “△” 修改位置;
7. 环保符合RoHS和REACH要求
8. 光电特性参数:

10. 9点亮度测试点

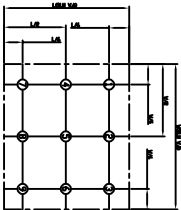

9 LED 电路图: 8串X5并=40LED

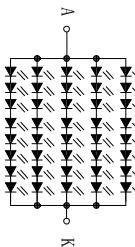

Item	Symbol	Min	Typ	Max	Unit	Condition
LCM	Luminance (General)	Lv	600	750	—	cd/m ²
	Uniformity (Uniform)	Av	75	80	—	%
	Colour	X	0.25	0.30	0.35	—
Coordinate	Y	0.26	0.31	0.36	—	—
	Vf	21.6	24.5	27.2	V	—
Reverse Voltage	Ir	—	—	—	mA	Vr= 5.0 V

●Operating Temperature: -30~+85° C ●Storage Temperature: -40~+90° C

Kingtech Group Co., Ltd.

UNIT	mm	TITLE	模组工程图	NAME	DATE
RATIO:	1 : 1	PRODUCT NO	PV101029S0140X	DRAWN BY	YF_CHEN/21.07.30
VIEW:		CUSTOMER NO		CHECKED BY	
		REV	C1	APPROVED BY	

A B C D E F G H I J K L M

9

8

7

6

5

4

3

2

1



8. Package Drawing

TBD



9.DEFINITION OF LABELS

The barcode nameplate is pasted on each module as illustration, and its definitions are as following explanation.



- (a) Model Name: PV101029S0140X
- (b) Serial ID: XXXXX Y W XXXX XXXXX

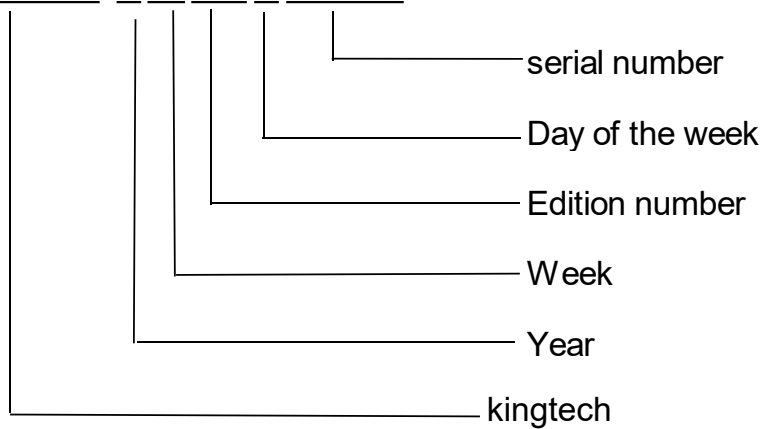

Serial ID includes the information as below:

- (a) Manufactured Date:
 - Year: 00~99,...2019=19, 2020=20, 2021=21...,2028=28.
 - Week: 01~56, first week of the year=01; second week of the year=02;...
 - Day of the week: A~G=Monday~Sunday
- (b) Edition number: cover all the change; A1,A2... Sample order;
C for mass production, C1, C2... change of order
- (c) Serial No.: Manufacturing sequence of product