





SPECIFICATION

Product Model:PV06803H0140D

DESIGNED	CHECKED	Approved
		

Ok

NG, Problem survey

Approved By_____

**DOCUMENT REVISION HISTORY**

Version	DATE	DESCRIPTION	CHANGED BY
V0	2022.5.17	New design	



CONTENTS	PAGE
1. Features & Mechanical specifications	1
2. Dimensional Outline	2
3. Block Diagram	3
4. Pin Description	4
5. Absolute Maximum Ratings	5
6. Electrical Characteristics	5
7. Backlight Specification	5
8. Electro-Optical Characteristics	6~7
9. Instruction Description	8
10. AC Characteristics	8
11. Quality Specification	9~17



A. Features & Mechanical Specifications

Item	Contents	Unit
	LCD	
LCD Type	TFT Transmissive Normal Black	--
Viewing direction	ALL.O'CLOCK	--
Backlight	White LED x12in Parallel/ Series	--
Interface	MIPI	--
Driver IC	ICN9707	--
Outline Dimension	66.7*181*4.7±0.25	mm
Glass area (W×H×T)	63.4208*169.0888*1.0	mm
Active area (W×H)	60.22*160.59	mm
Number of Dots	480*1280	--
Pixel pitch (W×H)	41.82*3*125.46	um
Operating Temperature	-20 ~ +70	°C
Storage temperature	-30 ~ +80	°C



B. Dimensional Outline

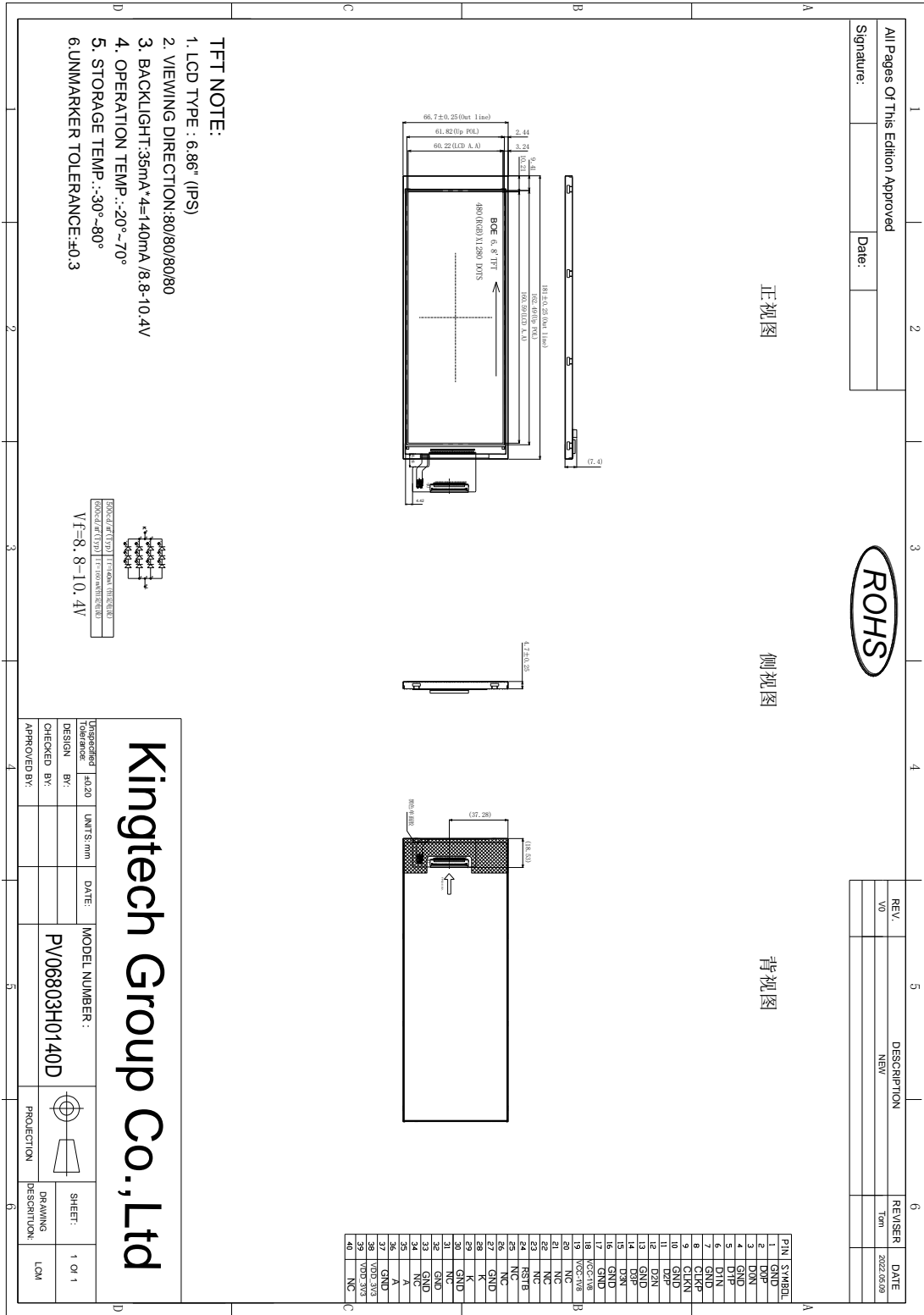



C. Block Diagram

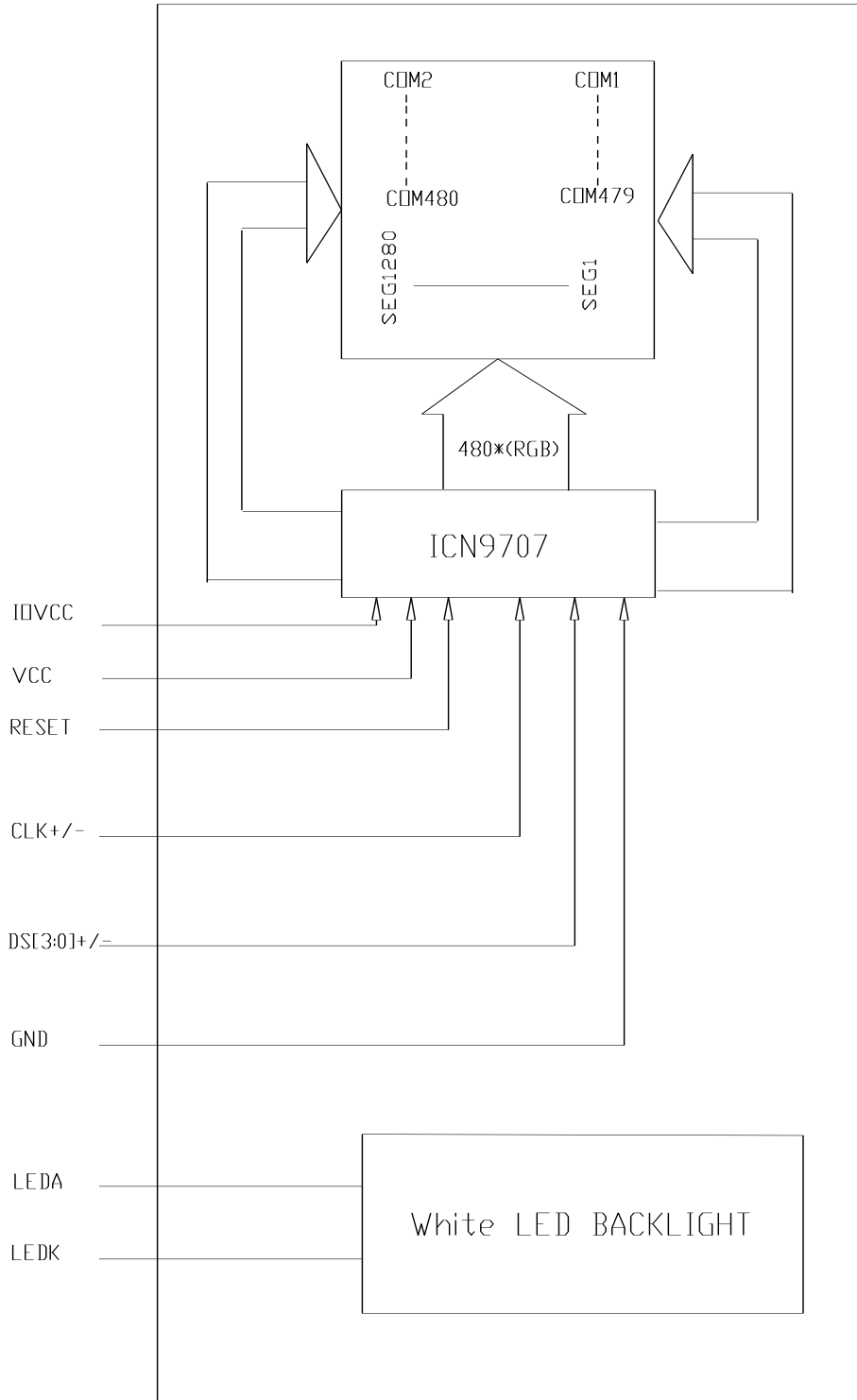



4. Pin Description

PIN No.	SYMBOL	Function
1	GND	Ground
2	DSI-D0P	DSI Data differential signal input pins. (Data lane0)
3	DSI-D0N	DSI Data differential signal input pins. (Data lane 0)
4	GND	Ground
5	DSI-D1P	DSI Data differential signal input pins. (Data lane 1)
6	DSI-D1N	DSI Data differential signal input pins. (Data lane 1)
7	GND	Ground
8	DSI-CLK P	DSI CLOCK differential signal input pins
9	DSI-CLK N	DSI CLOCK differential signal input pins
10	GND	Ground
11	DSI-D2P	DSI Data differential signal input pins. (Data lane 2)
12	DSI-D2N	DSI Data differential signal input pins. (Data lane 2)
13	GND	Ground
14	DSI-D3P	DSI Data differential signal input pins. (Data lane 3)
15	DSI-D3N	DSI Data differential signal input pins. (Data lane 3)
16-17	GND	Ground
18-19	IOVCC	I/O Power supply
20-23	NC	NC
24	RESET	Reset Signal pin ("Low" is enable)
25-26	NC	NC
27	GND	Ground
28-29	LEDK	Backlight LED Cathode
30	GND	Ground
31	NC	NC
32-33	GND	Ground
34	NC	NC
35-36	LEDA	Backlight LED Anode.
37	GND	Ground
38-39	VCC	Logic Power supply
40	NC	NC



5. Absolute Maximum Ratings

Item	Symbol	Rating			Unit
		MIN.	TYP.	MAX	
Operating Temperature range	TOP	-20	-	+70	°C
Storage Temperature range	TST	-30	-	+80	°C

6. Electrical Characteristics

DC Characteristics

Item	Symbol	Min.	Type.	Max.	Unit
Logic Supply Voltage	VDD	2.8	-	3.3	V
I/O Supply Voltage	IOVCC	1.8	-	3.3	V

注：复位电压需与 IOVCC 电压保持一致,没有 IOVCC 时复位电压需与 VCC 保持一致。

7. Backlight Characteristics

White LED × 12 in Parallel/ Series

(Ta = 25 °C)

Item	Symbol	Condition	Min	Typ	Max	Unit
Forward Voltage	VF	IF=140mA	8.8	-	10.4	V
Uniformity	Δ Bp	-	80	-	-	%
Luminance for LCD	Lv	IF=140mA	450	500	-	cd/m ²



8. Electro-Optical Characteristics

Using LC+ Normal Polarizer+Corresponding Backlight, reference only (Note 1,Note 2)

Parameter		Symbol	Condition	Min.	Typ.	Max.	Unit	Remark
Viewing Angle range	Horizontal	Θ_3	CR > 10	-	80	-	Deg.	Note 1
		Θ_9		-	80	-	Deg.	
	Vertical	Θ_{12}		-	80	-	Deg.	
		Θ_6		-	80	-	Deg.	
Contrast ratio		CR	$\Theta = 0^\circ$	-	800	-		Note 2
Transmittance		Tr		-	4.5	-	%	Base on C Light Note 3
White Chromaticity		x_w		-	0.298	-		Note 4 CF Glass Base on C Light
		y_w		-	0.328	-		
Reproduction of color (C light)	Red	R_x		-	0.659	-		
		R_y		-	0.322	-		
	Green	G_x		-	0.290	-		
		G_y		-	0.588	-		
	Blue	B_x		-	0.134	-		
		B_y		-	0.124	-		
Response Time (Rising + Falling)		$T_r + T_f$	Ta= 25° C $\Theta = 0^\circ$	-	30	35	ms	Note 5



***Note(3) Definition of Viewing Angle**

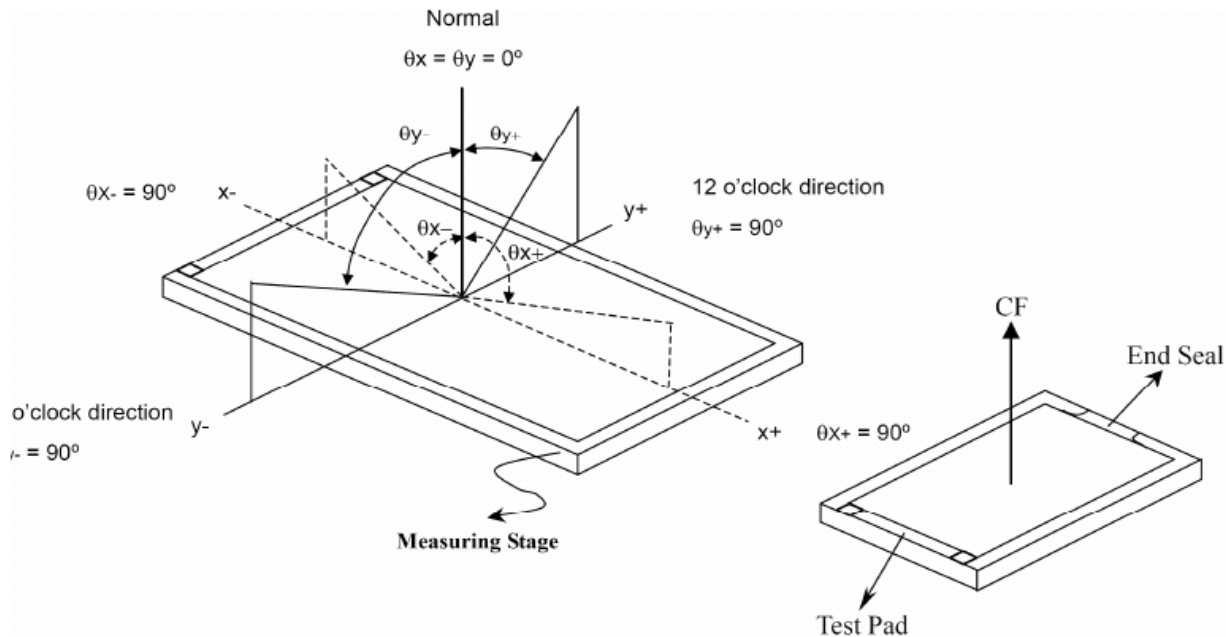

*** The above "Viewing Angle" is the measuring position with Largest Contrast Ratio; not for good image quality. View Direction for good image quality is 6 O'clock. Module maker can increase the "Viewing Angle" by applying Wide View Film.

***Note (4) Measurement Set-Up:**

The LCD module should be stabilized at a given temperature for 20 minutes to avoid abrupt temperature change during measuring. In order to stabilize the luminance, the measurement should be executed after lighting Backlight for 20 minutes in a windless room.

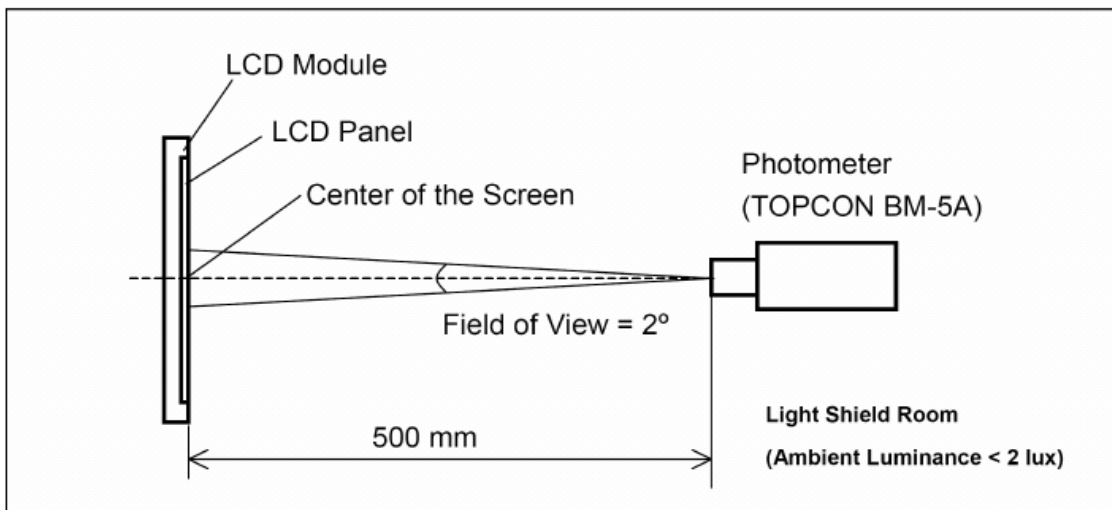



9. Instruction Description

Please refer to ICN9707

10. AC Characteristics

4.5.1 High Speed Mode - Clock Timings

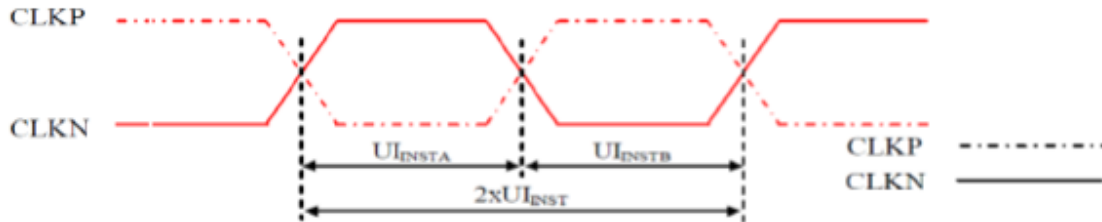

Figure 4.5.1-1: Clock Timing

Signal	Symbol	Parameter	Specification			Unit	Notes
			MIN	TYP	MAX		
CLK P/N	2xUI_INST	Double UI instantaneous	4		25	nS	
CLK P/N	UI_INSTA, UI_INSTB	UI instantaneous Half	2		12.5	nS	1

Note 1: UI = UI_INSTA = UI_INSTB

4.5.2 High Speed Mode - Clock / Data Timings

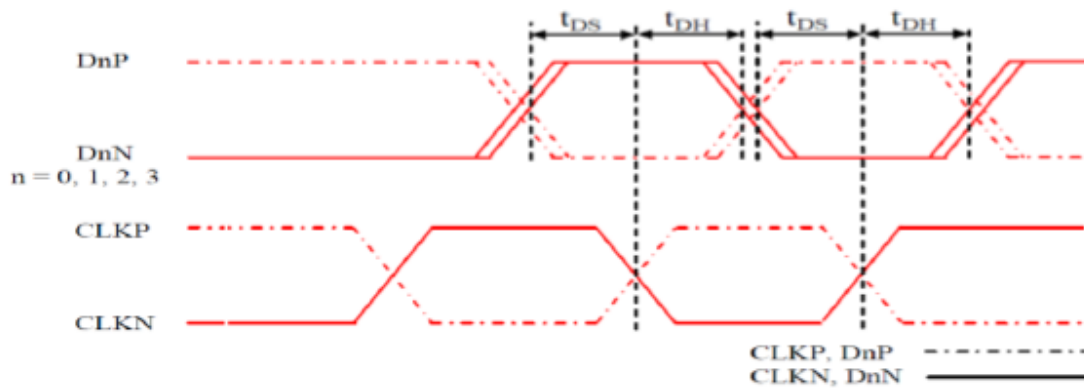

Figure 4.5.2-1: DSI Clock / Data Timings

Signal	Symbol	Parameter	Specification			Unit	Notes
			MIN	TYP	MAX		
Dn P/N (n=0,1,2 and 3)	t _{DS}	Data to Clock Setup time	0.15*UI			UI	
	t _{DH}	Clock to Data Hold time	0.15*UI			UI	



11. Quality Specifications

All The raw material are Rohs compllicant.

11.1 Standard of the product appearance test

Manner of appearance test: The inspection should be performed in using 20W x 2 fluorescent lamps.

Distance between LCM and fluorescent lamps should be 100 cm or more. Distance between LCM and inspector eyes should be 30 cm or more.

Viewing direction for inspection is 45° from vertical against LCM.

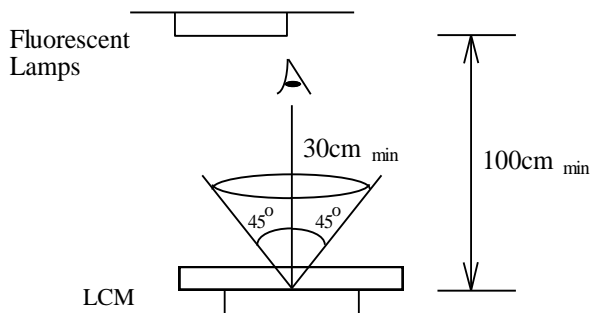

Definition of zone:

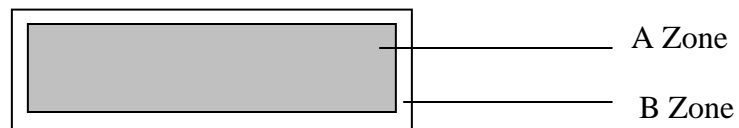

A Zone: viewing area

B Zone: outside viewing area



11.2 Specification of quality assurance

AQL inspection standard

Sampling method: MIL-STD-105E, Level II, single sampling

Defect classification (Note: * is not including)

Classify	Item		Note	AQL
Major	Display state	Short or open circuit	1	0.65
		LC leakage		
		Flickering		
		No display		
		Wrong viewing direction		
		Contrast defect (dim, ghost)	2	
	Back-light	1,8		
	Non-display	Flat cable or pin reverse	10	
Wrong or missing component		11		
Minor	Display state	Background color deviation	2	1.0
		Black spot and dust	3	
		Line defect, Scratch	4	
		Rainbow	5	
		Chip	6	
		Pin hole	7	
	Polarizer	Protruded	12	
		Bubble and foreign material	3	
	Soldering	Poor connection	9	
	Wire	Poor connection	10	
	TAB	Position, Bonding strength	13	

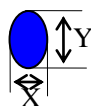
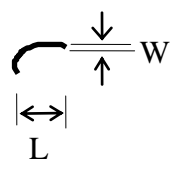

Note on defect classification

No.	Item	Criterion																				
1	Short or open circuit	Not allow																				
	LC leakage																					
	Flickering																					
	No display																					
	Wrong viewing direction																					
	Wrong Back-light																					
2	Contrast defect	Refer to approval sample																				
	Background color deviation																					
3	Point defect, Black spot, dust (including Polarizer) $\phi = (X+Y)/2$	 <table border="1" data-bbox="901 892 1339 1186"> <thead> <tr> <th>Point Size</th> <th>Acceptable Qty.</th> </tr> </thead> <tbody> <tr> <td>$\phi \leq 0.10$</td> <td>Disregard</td> </tr> <tr> <td>$0.10 < \phi \leq 0.20$</td> <td>2 (距离大于 5mm)</td> </tr> <tr> <td>$0.20 < \phi \leq 0.25$</td> <td>1</td> </tr> <tr> <td>$\phi > 0.25$</td> <td>0</td> </tr> </tbody> </table> <p>Unit: mm</p>	Point Size	Acceptable Qty.	$\phi \leq 0.10$	Disregard	$0.10 < \phi \leq 0.20$	2 (距离大于 5mm)	$0.20 < \phi \leq 0.25$	1	$\phi > 0.25$	0										
Point Size	Acceptable Qty.																					
$\phi \leq 0.10$	Disregard																					
$0.10 < \phi \leq 0.20$	2 (距离大于 5mm)																					
$0.20 < \phi \leq 0.25$	1																					
$\phi > 0.25$	0																					
4	Line defect, Scratch	 <table border="1" data-bbox="836 1312 1380 1585"> <thead> <tr> <th colspan="2">Line</th> <th>Acceptable Qty.</th> </tr> <tr> <th>L</th> <th>W</th> <th></th> </tr> </thead> <tbody> <tr> <td>---</td> <td>$0.015 \geq W$</td> <td>Disregard</td> </tr> <tr> <td>$3.0 \geq L$</td> <td>$0.03 \geq W$</td> <td rowspan="2">2</td> </tr> <tr> <td>$2.0 \geq L$</td> <td>$0.05 \geq W$</td> </tr> <tr> <td>$1.0 \geq L$</td> <td>$0.1 > W$</td> <td>1</td> </tr> <tr> <td>---</td> <td>$0.05 < W$</td> <td>Applied as point defect</td> </tr> </tbody> </table> <p>Unit: mm</p>	Line		Acceptable Qty.	L	W		---	$0.015 \geq W$	Disregard	$3.0 \geq L$	$0.03 \geq W$	2	$2.0 \geq L$	$0.05 \geq W$	$1.0 \geq L$	$0.1 > W$	1	---	$0.05 < W$	Applied as point defect
Line		Acceptable Qty.																				
L	W																					
---	$0.015 \geq W$	Disregard																				
$3.0 \geq L$	$0.03 \geq W$	2																				
$2.0 \geq L$	$0.05 \geq W$																					
$1.0 \geq L$	$0.1 > W$	1																				
---	$0.05 < W$	Applied as point defect																				
5	Rainbow	Not more than two color changes across the viewing area.																				

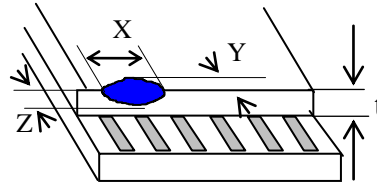
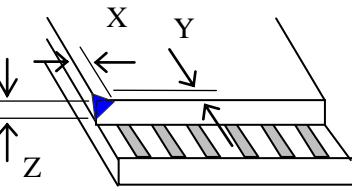
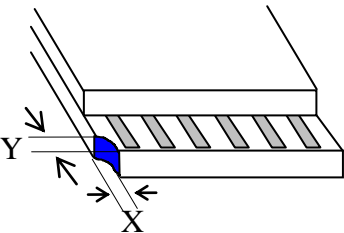
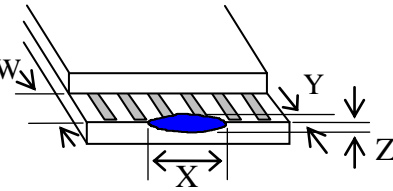
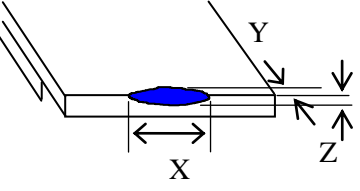

No	Item	Criterion																																	
6	<p>Chip</p> <p>Remark: X: Length direction Y: Short direction Z: Thickness direction t: Glass thickness W: Terminal Width</p>	<div style="display: flex; flex-direction: column; align-items: flex-start;"> <div style="display: flex; align-items: center; margin-bottom: 20px;">  <div style="margin-left: 20px;"> <p>Acceptable criterion</p> <table border="1" style="border-collapse: collapse; text-align: center;"> <thead> <tr> <th>X</th> <th>Y</th> <th>Z</th> </tr> </thead> <tbody> <tr> <td>≤2</td> <td>0.5mm</td> <td>≤t/2</td> </tr> </tbody> </table> </div> </div> <div style="display: flex; align-items: center; margin-bottom: 20px;">  <div style="margin-left: 20px;"> <p>Acceptable criterion</p> <table border="1" style="border-collapse: collapse; text-align: center;"> <thead> <tr> <th>X</th> <th>Y</th> <th>Z</th> </tr> </thead> <tbody> <tr> <td>≤2</td> <td>0.5mm</td> <td>≤t</td> </tr> </tbody> </table> </div> </div> <div style="display: flex; align-items: center; margin-bottom: 20px;">  <div style="margin-left: 20px;"> <p>Acceptable criterion</p> <table border="1" style="border-collapse: collapse; text-align: center;"> <thead> <tr> <th>X</th> <th>Y</th> <th>Z</th> </tr> </thead> <tbody> <tr> <td>≤3</td> <td>≤2</td> <td>≤t</td> </tr> <tr> <td colspan="2">shall not reach to ITO</td> <td></td> </tr> </tbody> </table> </div> </div> <div style="display: flex; align-items: center; margin-bottom: 20px;">  <div style="margin-left: 20px;"> <p>Acceptable criterion</p> <table border="1" style="border-collapse: collapse; text-align: center;"> <thead> <tr> <th>X</th> <th>Y</th> <th>Z</th> </tr> </thead> <tbody> <tr> <td>Disregard</td> <td>≤0.2</td> <td>≤t</td> </tr> </tbody> </table> </div> </div> <div style="display: flex; align-items: center;">  <div style="margin-left: 20px;"> <p>Acceptable criterion</p> <table border="1" style="border-collapse: collapse; text-align: center;"> <thead> <tr> <th>X</th> <th>Y</th> <th>Z</th> </tr> </thead> <tbody> <tr> <td>≤5</td> <td>≤2</td> <td>≤t/3</td> </tr> </tbody> </table> </div> </div> </div>	X	Y	Z	≤2	0.5mm	≤t/2	X	Y	Z	≤2	0.5mm	≤t	X	Y	Z	≤3	≤2	≤t	shall not reach to ITO			X	Y	Z	Disregard	≤0.2	≤t	X	Y	Z	≤5	≤2	≤t/3
X	Y	Z																																	
≤2	0.5mm	≤t/2																																	
X	Y	Z																																	
≤2	0.5mm	≤t																																	
X	Y	Z																																	
≤3	≤2	≤t																																	
shall not reach to ITO																																			
X	Y	Z																																	
Disregard	≤0.2	≤t																																	
X	Y	Z																																	
≤5	≤2	≤t/3																																	

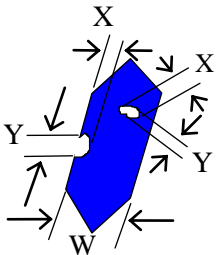
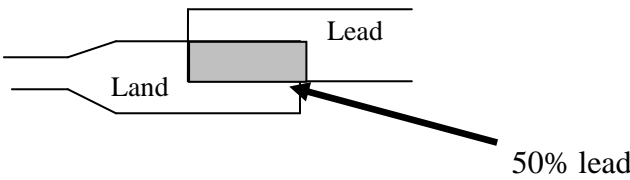

No.	Item	Criterion								
7	Segment pattern W = Segment width $\phi = (X+Y)/2$	<p>(1) Pin hole</p> <p>$\phi < 0.10\text{mm}$ is acceptable.</p>  <table border="1" data-bbox="901 514 1356 682"> <thead> <tr> <th>Point Size</th> <th>Acceptable Qty</th> </tr> </thead> <tbody> <tr> <td>$\phi \leq 1/4W$</td> <td>Disregard</td> </tr> <tr> <td>$1/4W < \phi \leq 1/2W$</td> <td>1</td> </tr> <tr> <td>$\phi > 1/2W$</td> <td>0</td> </tr> </tbody> </table> <p>Unit: mm</p>	Point Size	Acceptable Qty	$\phi \leq 1/4W$	Disregard	$1/4W < \phi \leq 1/2W$	1	$\phi > 1/2W$	0
Point Size	Acceptable Qty									
$\phi \leq 1/4W$	Disregard									
$1/4W < \phi \leq 1/2W$	1									
$\phi > 1/2W$	0									
8	Back-light	<p>D. The color of backlight should correspond its specification.</p> <p>E. Not allow flickering</p>								
9	Soldering	<p>F. Not allow heavy dirty and solder ball on PCB. (The size of dirty refer to point and dust defect)</p> <p>G. Over 50% of lead should be soldered on Land.</p> 								
10	Wire	<p>H. Copper wire should not be rusted</p> <p>I. Not allow crack on copper wire connection.</p> <p>J. Not allow reversing the position of the flat cable.</p> <p>K. Not allow exposed copper wire inside the flat cable.</p>								
11*	PCB	<p>L. Not allow screw rust or damage.</p> <p>M. Not allow missing or wrong putting of component.</p>								

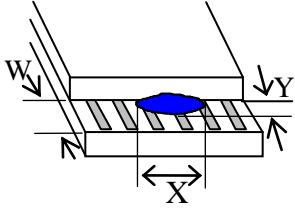
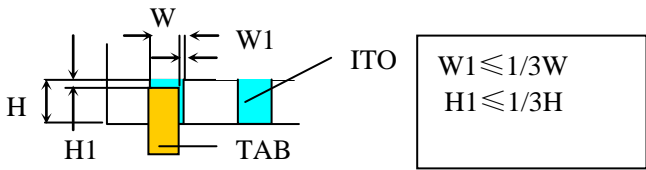
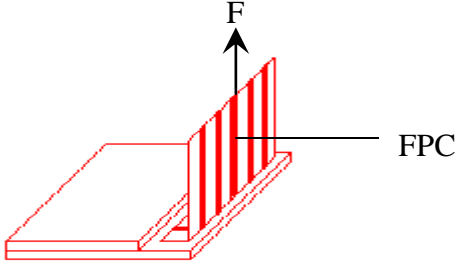

No	Item	Criterion
12	Protruded W: Terminal Width	 <p>Acceptable criteria: $Y \leq 0.4$</p>
13	TAB	<p>1. Position</p>  <p> $W1 \leq 1/3W$ $H1 \leq 1/3H$ </p> <p>2 FPC bonding strength test</p>  <p> $P (=F/FPC \text{ bonding width}) \geq 650gf/cm$,(speed rate: 1mm/min) 5pcs per SOA (shipment) </p>
14	Total no. of acceptable Defect	<p>N. Zone</p> <p>Maximum 2 minor non-conformities per one unit. Defect distance: each point to be separated over 10mm</p> <p>B. Zone</p> <p>It is acceptable when it is no trouble for quality and assembly in customer's end product.</p>



11.3 Reliability of LCM

Reliability test condition:

Item	Condition	Time (hrs)	Assessment
High temp. Storage	80°C	48	No abnormalities in functions and appearance
High temp. Operating	70°C	48	
Low temp. Storage	-30°C	48	
Low temp. Operating	-20°C	48	
Humidity	60°C/ 90%RH	48	
Temp. Cycle	-30°C ← 25°C →80°C (60 min ← 5 min → 60min)	10cycles	

Recovery time should be 24 hours minimum. Moreover, functions, performance and appearance shall be free from remarkable deterioration within 50,000 hours under ordinary operating and storage conditions room temperature (20±8°C), normal humidity (below 65% RH), and in the area not exposed to direct sun light.



11.4 Precaution for using LCD/LCM

LCD/LCM is assembled and adjusted with a high degree of precision. Do not attempt to make any alteration or modification. The followings should be noted.

General Precautions:

- O. LCD panel is made of glass. Avoid excessive mechanical shock or applying strong pressure onto the surface of display area.
- P. The polarizer used on the display surface is easily scratched and damaged. Extreme care should be taken when handling. To clean dust or dirt off the display surface, wipe gently with cotton, or other soft material soaked with isopropyl alcohol, ethyl alcohol or trichlorotrifluoroethane, do not use water, ketone or aromatics and never scrub hard.
- Q. Do not tamper in any way with the tabs on the metal frame.
- R. Do not made any modification on the PCB without consulting KINGTECH .
- S. When mounting a LCM, make sure that the PCB is not under any stress such as bending or twisting. Elastomer contacts are very delicate and missing pixels could result from slight dislocation of any of the elements.
- T. Avoid pressing on the metal bezel, otherwise the elastomer connector could be deformed and lose contact, resulting in missing pixels and also cause rainbow on the display.
- U. Be careful not to touch or swallow liquid crystal that might leak from a damaged cell. Any liquid crystal adheres to skin or clothes, wash it off immediately with soap and water.

Static Electricity Precautions:

- V. CMOS-LSI is used for the module circuit; therefore operators should be grounded whenever he/she comes into contact with the module.
- W. Do not touch any of the conductive parts such as the LSI pads; the copper leads on the PCB and the interface terminals with any parts of the human body.
- X. Do not touch the connection terminals of the display with bare hand; it will cause disconnection or defective insulation of terminals.
- Y. The modules should be kept in anti-static bags or other containers resistant to static for storage.
- Z. Only properly grounded soldering irons should be used.
- AA. If an electric screwdriver is used, it should be grounded and shielded to prevent sparks.
- BB. The normal static prevention measures should be observed for work clothes and working benches.
- CC. Since dry air is inductive to static, a relative humidity of 50-60% is recommended.

**Soldering Precautions:**

- DD. Soldering should be performed only on the I/O terminals.
- EE. Use soldering irons with proper grounding and no leakage.
- FF. Soldering temperature: $280^{\circ}\text{C} \pm 10^{\circ}\text{C}$
- GG. Soldering time: 3 to 4 second.
- HH. Use eutectic solder with resin flux filling.
- II. If flux is used, the LCD surface should be protected to avoid spattering flux.
- JJ. Flux residue should be removed.

Operation Precautions:

- KK. The viewing angle can be adjusted by varying the LCD driving voltage V_o .
 - LL. Since applied DC voltage causes electro-chemical reactions, which deteriorate the display, the applied pulse waveform should be a symmetric waveform such that no DC component remains. Be sure to use the specified operating voltage.
 - MM. Driving voltage should be kept within specified range; excess voltage will shorten display life.
 - NN. Response time increases with decrease in temperature.
 - OO. Display color may be affected at temperatures above its operational range.
6. Keep the temperature within the specified range usage and storage. Excessive temperature and humidity could cause polarization degradation, polarizer peel-off or generate bubbles.
 7. For long-term storage over 40°C is required, the relative humidity should be kept below 60%, and avoid direct sunlight.

Limited Warranty

Kingtech LCDs and modules are not consumer products, but may be incorporated by Kingtech 's customers into consumer products or components thereof, Kingtech does not warrant that its LCDs and components are fit for any such particular purpose.

PP. The liability of Kingtech is limited to repair or replacement on the terms set forth below. Kingtech will not be responsible for any subsequent or consequential events or injury or damage to any personnel or user including third party personnel and/or user. Unless otherwise agreed in writing between Kingtech and the customer, Kingtech will only replace or repair any of its LCD which is found defective electrically or visually when inspected in accordance with Kingtech general LCD inspection standard. (Copies available on request)

- QQ. No warranty can be granted if any of the precautions state in handling liquid crystal display above has been disregarded. Broken glass, scratches on polarizer mechanical damages as well as defects that are caused accelerated environment tests are excluded from warranty.
- RR. In returning the LCD/LCM, they must be properly packaged; there should be detailed description of the failures or defect.