



Technical Product Specification

Customer: _____

Model Name: _____ PV08010T0630K _____

Customer Type: _____

Date: _____ 2019-12-20 _____

Version: _____ 00 _____

- Preliminary Specification
- Final Specification

For Customer's Acceptance

Approved by	Comment

Approved by	Reviewed by	Prepared by



Table of Contents

1.FEATURES	4
2.GENERAL SPECIFICATIONS	4
3. INPUT/OUTPUT TERMINALS	5
3.1 CN1 PIN ASSIGNMENT	5
4.ABSOLUTE MAXIMUM RATINGS	6
5. ELECTRICAL CHARACTERISTICS.....	7
5.1 DC CHARACTERISTICS FOR PANEL DRIVING.....	7
5.2 RECOMMENDED POWER ON/OFF SEQUENCE.....	9
5.3 LCD MODULE BLOCK DIAGRAM.....	10
5.4 DRIVING BACKLIGHT.....	10
6. TIMING CHARACTERISTICS	12
6.1 INPUT TIMING	12
6.2 LVDS TIMING	13
7. OPTICAL CHARACTERISTICS	15
8. RELIABILITY TEST	18
8.1 CONTENT OF RELIABILITY TEST	18
10. PRODUCT INSPECTION CRITERIA.....	21
10.1 INCOMING INSPECTION	21
10.2 INSPECTION SAMPLING METHOD	21
10.3 INSPECTION CONDITIONS.....	21
10.4 COSMETIC INSPECTION CRITERIA.....	22
11.PACKING INSTRUCTION	24
12.PRECAUTIONS FOR USE OF LCD MODULE	25
12.1 HANDLING PRECAUTIONS	25
12.2 STORAGE PRECAUTIONS.....	25
12.3 TRANSPORTATION PRECAUTIONS.....	26
13. APPENDIX TABLE	26



1.Features

This is an 8.0 inch Amorphous-TFT-LCD (Thin Film Transistor Liquid Crystal Display) Normally Black technology module, which is composed of a TFT-LCD panel, LCD Driver IC with T-con integrated, FPC unit. It is designed for Automotive and other high reliability electronic products and complies with the RoHS environmental protection directive.

2.General Specifications

	Feature	Spec	Remark
Display Spec.	Size	8.0 inch	
	Resolution	1280(RGB)x720	
	Interface	One-port LVDS 24 bits VESA	
	Color Depth	16.7 M	
	Technology Type	a-Si	
	Pixel Pitch (mm)	0.138 x 0.138	
	Pixel Configuration	R.G.B. Vertical Stripe	
	Active Area(mm)	176.64 x 99.36	
	Display Mode	Normally Black SFT technology	
	Surface Treatment (LCD Upper Polarizer)	HC	
	Gray Scale Inversion Direction	No gray inversion.	
	Viewing Direction	Landscape Mode Optimized	
Polarizer Sunglass Compatible	Yes		
Mechanical Characteristics	LCM (W x H x D) (mm)	192.8x116.9x 7.0	Note 2
	Weight (g)	215(Typ)	Note 3

Table 2.1 General TFT Specifications

Note 1: Requirements on Environmental Protection: ROHS.

Note 2: The height dimension does not include the length of FPC.

Note 3: LCM weight tolerance: $\pm 5\%$



3. Input/output Terminals

3.1 CN1 pin assignment

Recommended Mating Connector type: FH28D-30S-0.5SH(Hirose)

No	Symbol	I/O	Description	Remark
1	NC	N	MUST be non-connection.	
2	VDD	P	Power supply 3.3V(typ)	
3	VDD	P	Power supply 3.3V(typ)	
4	GND	P	Power Ground	
5	RESET	I	Global reset signal	
6	STBYB	I	Standby mode control signal	
7	GND	P	Power Ground	
8	SDA	I/O	Only for OTP use, Not connect	
9	SCL	I	Only for OTP use, Not connect	
10	CSB	I	Only for OTP use, Not connect	
11	GND	P	Power Ground	
12	TB	I	Vertical shift direction (gate output) selection	
13	RL	I	Horizontal shift direction (source output) selection	
14	GND	P	Power Ground	
15	LV0N	I	Negative LVDS Differential data input(0)	
16	LV0P	I	Positive LVDS Differential data input(0)	
17	GND	P	Power Ground	
18	LV1N	I	Negative LVDS Differential data input(1)	
19	LV1P	I	Negative LVDS Differential data input(1)	
20	GND	P	Power Ground	
21	LV2N	I	Negative LVDS Differential data input(2)	
22	LV2P	I	Positive LVDS Differential data input(2)	
23	GND	P	Power Ground	
24	CLKN	I	Negative LVDS Differential clock input	
25	CLKP	I	Positive LVDS Differential clock input	
26	GND	P	Power Ground	
27	LV3N	I	Negative LVDS Differential data input(3)	
28	LV3P	I	Positive LVDS Differential data input(3)	
29	GND	P	Power Ground	
30	VDDOTP	P	Power input for OTP programming, Not connect	

Table 3.1.1 Pin assignment for TFT interface

Note1: All of GND pins should be connected to system ground.

Note2: I/O definition: I---Input, O---Output, P--- Power/Ground, N--- No connection

Note3: Description of Scan Direction.



4.Absolute Maximum Ratings

GND=0V, Ta = 25°C

Item	Symbol	Min	Max	Unit	Remark
Logic supply voltage	VDD	-0.5	5	V	Note2
Analog supply voltage	AVDD	10	13.5	V	
Gate on voltage	VGH	AVDD	3*AVDD	V	
Gate off voltage	VGL	-2*AVDD	-0	V	
Gate voltage range	VGH-VGL	AVDD	5*AVDD	V	
Backlight Forward Current	If		100	mA	
Backlight Forward Voltage	V _{BL}	-	20.4	V	Note 5
Operating Temperature	Top	-30	85	°C	Note1/2
Storage Temperature	Tst	-40	90	°C	/3/4

Table 4.1.1 Absolute Maximum Rating

Note1:The temperature is the surface temperature of module.

Note2: No Electro-optical specification are guaranteed below -30°C.

Note3: LED forward current should follow De-rating curve.

Note4: NTC resistance should not be below 1.4129 kΩ.

Note5: When power off LEDs,please use the design to avoid releasing reverse voltage

Note6: If the voltage exceeds its absolute maximum ratings, the LCM may be damaged.

Also, if the LCM is operated with the absolute maximum ratings for a long time, its reliability may drop.



5. Electrical Characteristics

5.1 DC Characteristics for Panel Driving

GND=0V, Ta = 25°C

Item	Symbol	MIN	TYP	MAX	Unit	Remark
Logic supply voltage	VDD	3.0	3.3	3.6	V	
VCC Current(DC)	Ivcc		260	400	mA	Note 1
Permissible Ripple Voltage of VCC	Vr			100	mV	Note 1
Input High Voltage	V _{IH}	0.7*VDD		VDD	V	Note 2
Input Low Voltage	V _{IL}	GND		0.3*VDD	V	
Differential Input High Voltage(threshold)	V _{th}	-	-	0.1	V	Note 3
Differential Input Low Voltage (threshold)	V _{tl}	-0.1	-	-	V	
Magnitude Differential Input Voltage	V _{id}	0.2	-	0.6	V	
Common Mode Voltage	V _{cm}	1	1.2	1.8- V _{id} /2	V	
Spread Spectrum Clocking Ratio	SSCR	23		93	kHz	
Pull High/Low Resistor	R _i	125	200	375	KΩ	

Table 5.1.1 Operating Voltages

Note1: Condition VDD=3.3V, white pattern, Typical input timing

Note2: RESET, STBYB, RL, TB

Note3: IC internal design value



Parameter	Symbol	Condition	Spec			Unit
			Min	Typ	Max	
Differential input high threshold voltage	V_{th}	$V_{CM}=1.2V$	+0.2	-	-	
Differential input low threshold voltage	V_{tl}		-	-	-0.2	
Differential input common mode voltage	V_{CM}	-	1	1.2	$1.7- V_{id} /2$	
LVDS input voltage	V_{INLV}	-	0.7	-	1.7	V
Δ LVDS common mode voltage	ΔV_{CM}	$1V < V_{CM} < 1.6V$	No limit	-	-	-
Differential input voltage	$ V_{id} $	-	0.2	-	0.6	V
Differential input leakage current	I_{lvleak}		-10	-	+10	μA
LVDS terminal match resistor	R_{LVDS}			100		Ω

Table 5.1.2 LVDS mode DC electrical characteristics

Note 1: Above of all these items spec is the precondition that panel can operate normally.

Note 2: This is preliminary SPEC, some of these items may be updated according to panel actually display quality and actually electrical characteristics.

Note 3: Description of $|V_{id}|$ is as below.

Single-end Signal

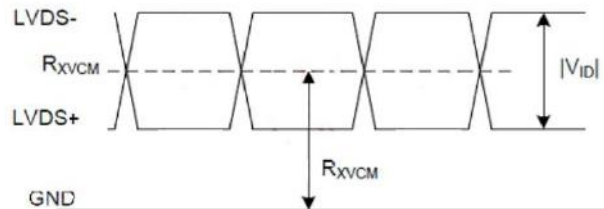

Differential Signal

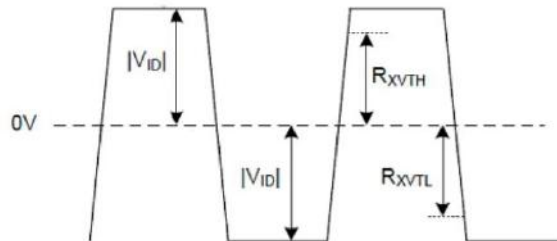
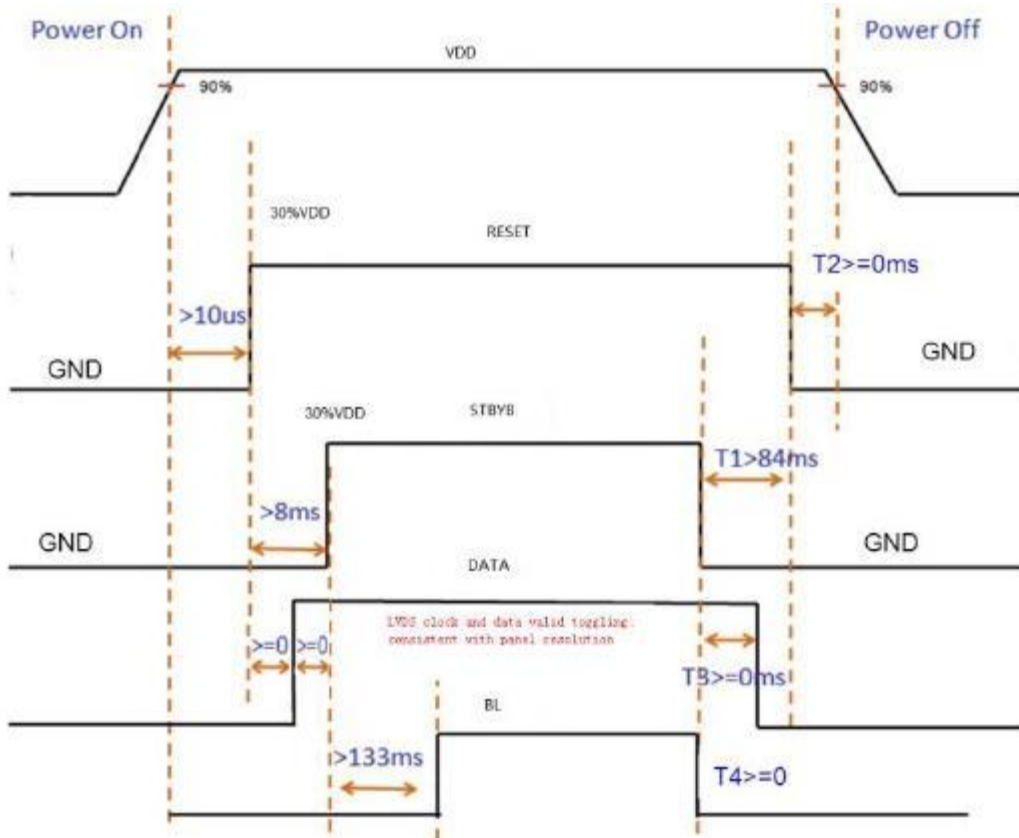

Table 5.1.3 Operating voltage



5.2 Recommended Power ON/OFF Sequence



5.2.1 Power on/off Sequenc

Note1: The low level of these signals and analog powers are GND level.

Note2: All of the power and signals should be kept at GND level before power on.

If there are residual voltages on them, the LCD might not work properly.

Note3: VLED is the voltage applied to backlight. Keep it turned off until the display has Stabilized.



5.3 LCD Module Block Diagram

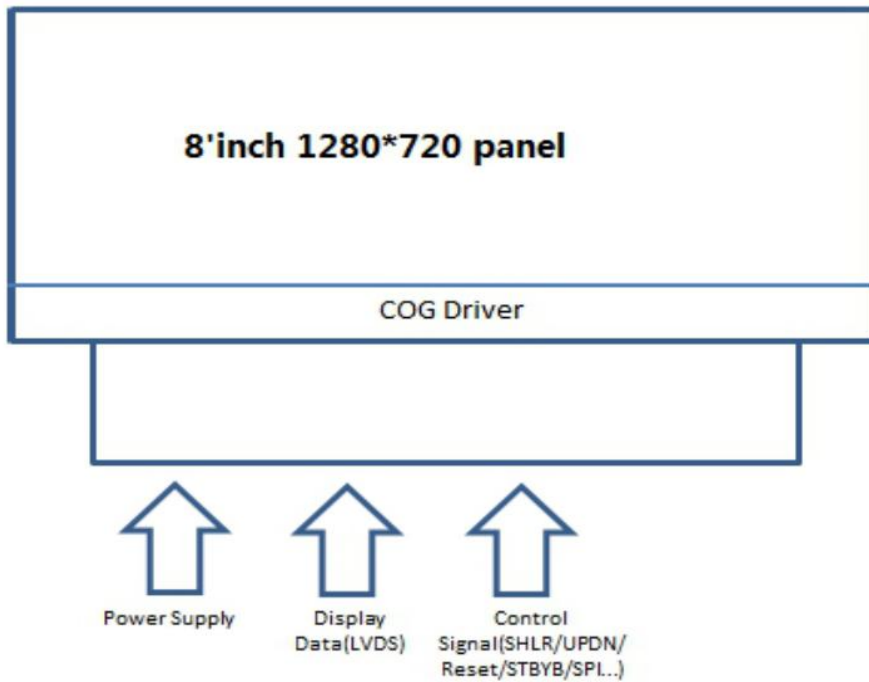
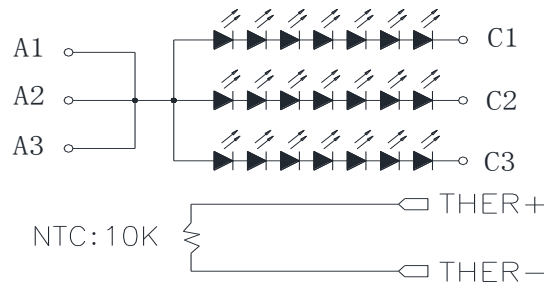

Figure 5.4.1 LCD Module Block Diagram

5.4 Driving Backlight

Backlight circuit diagram



Item	Symbol	VALUE			UNIT	Remark
		MIN	TYP	MAX		
Forward Voltage	V_{BL}	19.6	21.7	23.8	V	$I_f=285mA$
Forward Current per String	I_{BL}	-	285	360	mA	Note 1
Backlight Power Consumption	W_{BL}	-	6.2	-	W	95mA per String
Life Time	-	10000			Hrs	Note 2

Note 1: There are total three LED strings in backlight unit. While the LCM is operating a stable forward current should be input.



Note 2: Optical performance should be evaluated at Ta=25° C only, If the LEDs are driven high current or at high temperature & high humidity condition, the lifetime of the LEDs will be reduced. Operating lifetime means the brightness decrease to 70% of the original brightness.

Note 3: NTC thermistor is include the LED circuit and the part number is SDNT1005X103J3380HTF. It is used for the measuring LED temperature and is located in the middle of the LED circuit on the backlight FPC. Please refer to the appendix table which is the relationship of temperature -resistance for NTC.

Part number	SDNT1005X103J3380HTF	--
Resistance Tolerance	1%	Ta=25°
Permissive Operating Current	0.1mA	Ta=25°

Note 4: The de-rating curves for the backlight is shown following. The de-rating temperature is 25 ° C

TBD
De-rating Curve



6. Timing Characteristics

Frame rate=60Hz

6.1 Input timing

Parameter	Symbol	Unit	Min.	Typ.	Max.	REMARKS
Clock Frequency	f_{dck}	MHz	58.4	58.7	74.9	
H Total Time	T_{hp}	clocks	1340	1344	1470	
H Active Time	T_{hd}	clocks	1280			
H pulse width	T_{HPW}	clocks	16	-	40	
H back porch	T_{HBP}	clocks	48			
H front porch	T_{HFP}	clocks	12	16	142	
V Total Time	T_v	lines	726	728	849	
V Active Time	T_{vd}	lines	720			
V pulse width	T_{VPW}	lines	1	-	20	
V back porch	T_{VBP}	lines				
V front porch	T_{VFP}	lines	3	5	126	

Note: Above of all these information is just for reference, the final information should be based on the test result of module and be set for module in initial code.

6.1.1 Input timing chart

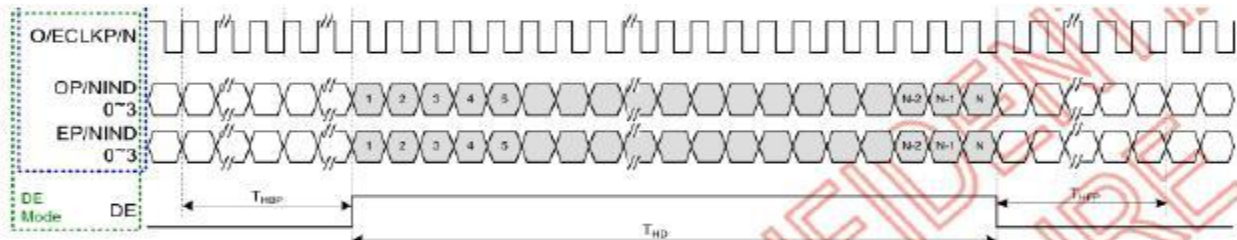

Figure 6.1.1 Horizontal input timing

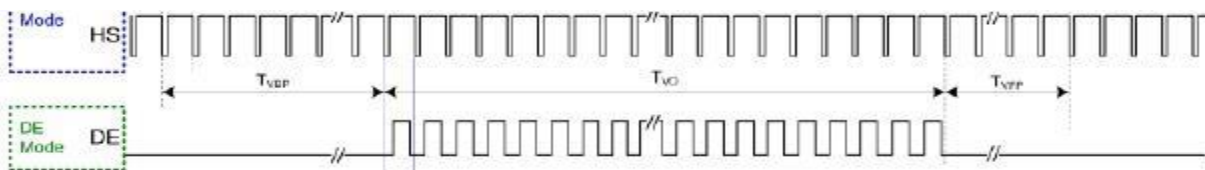

Figure 6.1.2 Vertical input timing



6.2 LVDS timing

Parameter	Symbol	Min.	Typ.	Max.	Unit	Condition
Clock frequency	FLVCLK	25	-	85	MHz	Refer to input timing table for each display resolution.
Clock Period	TLVCLK	40	-	11.76	nsec	
Clock high time	TLVCH	-	4/(7* RXFCLK)	-	ns	
Clock low time	TLVCL	-	3/(7* RXFCLK)	-	ns	
Input data skew margin	TRSKM	-	-	0.25	UI	VCC_IF=1.8V w/o SSC
Strobe width	TSW	0.5	-	-	UI	
1 data bit time	UI	-	1/7	-	TLV CLK	
Position 1	TPOS1	-0.25	0	0.25	UI	
Position 0	TPOS0	0.75	1	1.25	UI	
Position 6	TPOS6	1.75	2	2.25	UI	
Position 5	TPOS5	2.75	3	3.25	UI	
Position 4	TPOS4	3.75	4	4.25	UI	
Position 3	TPOS3	4.75	5	5.25	UI	
Position 2	TPOS2	5.75	6	6.25	UI	
PLL wake-up time	TenPLL	-	-	150	us	
Modulation Frequency	SSCMF	23	-	93	KHz	
Modulation Rate	SSCMR	-3	-	+3	%	LVDS clock = 81MHz, center spread

Table 6.2.1 LVDS mode AC electrical characteristics

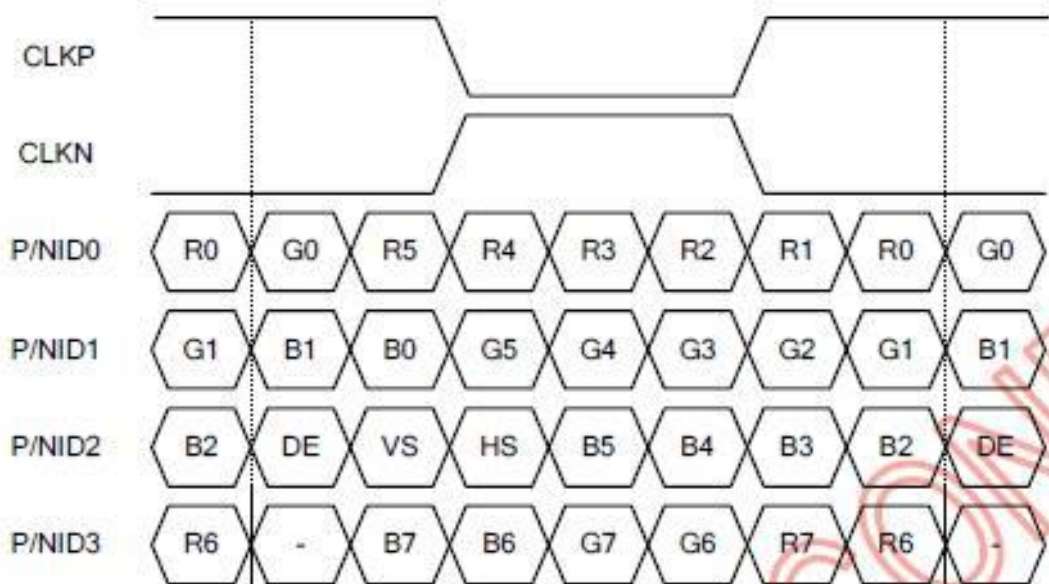

Figure 6.2.1 Single port 8-bit LVDS VESA

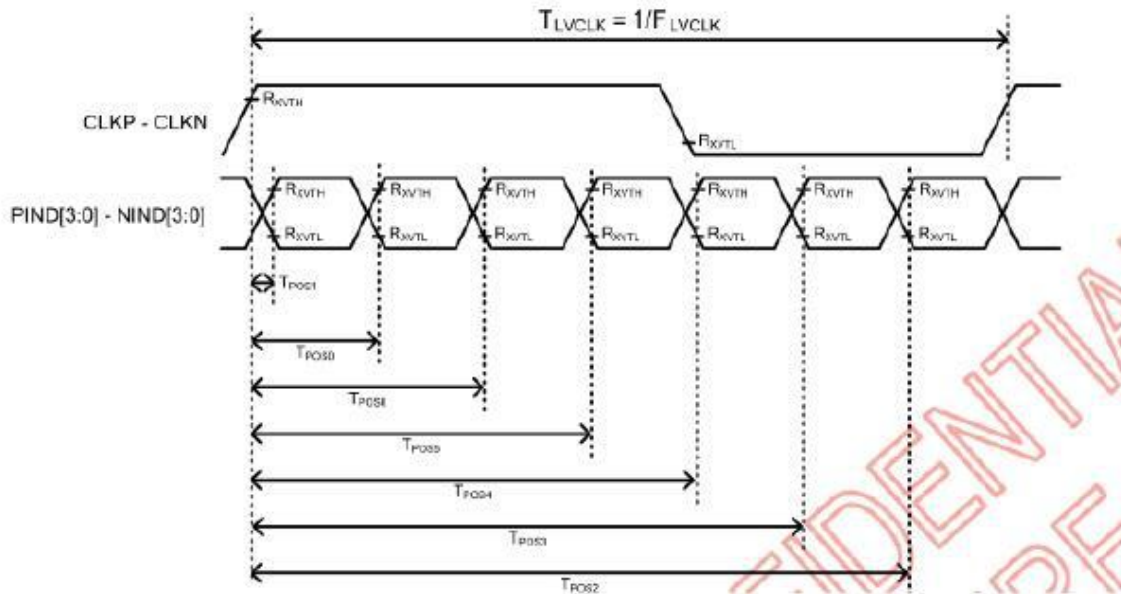

Figure 6.2.2 LVDS input timing

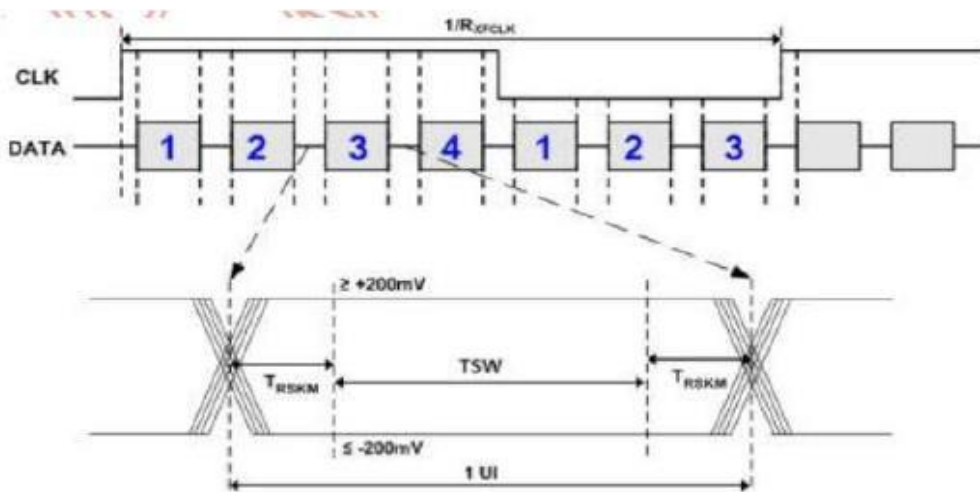

Figure 6.2.3 LVDS input eye diagram

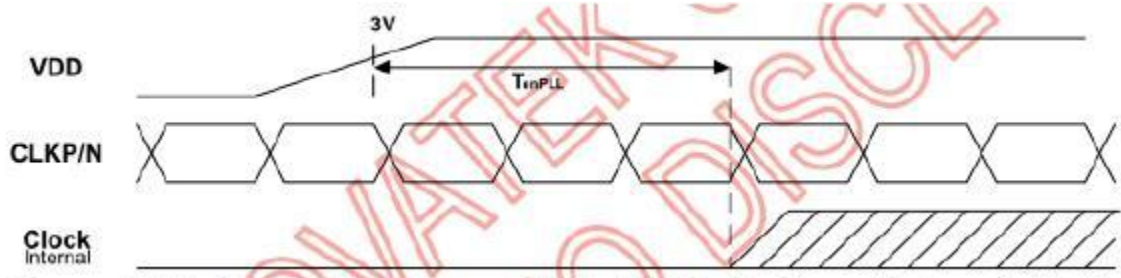

Figure 6.2.4 LVDS wake up time



7. Optical Characteristics

Item	Symbol	Condition	Min	Typ	Max	Unit	Remark
View Angles	θT	CR \geq 10:1	80	88	--	Degree	Note1 Note2
	θB		80	88	--		
	θL		80	88	--		
	θR		80	88	--		
Luminance	White	Perpendicular	800	1000	--	cd/m ²	Note 1
Contrast Ratio	CR	Perpendicular +25°C	1000:1	1500:1	--	-	Note3 Note6
Response Time	Ton+Toff	25°C	--	--	25	ms	Note4
		-20°C	--	--	200		
		-30°C	--	--	350		
Chromaticity	White	x	Backlight is on and perpendicular at +25°C		(0.299)	\pm 0.04	Note 5
		y			(0.329)		
	Red	x			(0.644)		
		y			(0.333)		
	Green	x			(0.314)		
		y			(0.635)		
	Blue	x			(0.152)		
		y			(0.063)		
Uniformity	Full White	Perpendicular +25°C	80	85	--	%	Note 7
NTSC	-	Perpendicular +25°C	70	75	--	%	Note 5
Flicker (50%Gray pattern)	--	JEIDA	--	--	-20	dB	Note9
Gamma	γ	VESA standard perpendicular	1.8	2.2	2.6	-	

Test Conditions:

1. $I_F = 95mA \times 3$ strings = 285mA, the panel surface temperature is 25°C.
2. The test systems refer to Note 1 and Note 2.

Note1: Definition of viewing angle range and measurement system

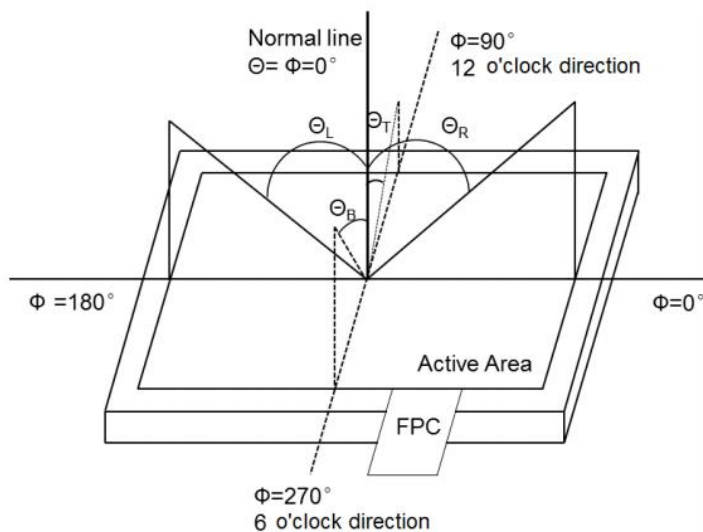

Note2: Definition of optical measurement system

Measured at the center of the panel by BM-7.

Measuring condition:



- Measuring surroundings: Dark room.
- Measuring temperature: $T_a = +25^\circ\text{C}$
- Adjust operating voltage to get optimum contrast at the center of the display.
- Measured value at the center point of LCD panel after more than 10 minutes while backlight is turned on.

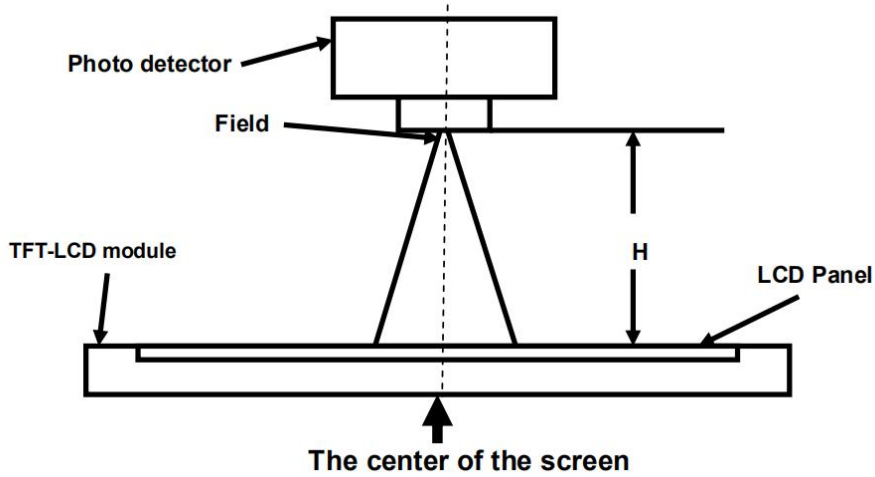

Item	Photo detector	Field	High
Contrast Ratio	BM-7	1°	H=500mm
Luminance			
Chromaticity			
Lum Uniformity			

Note3: Definition of contrast ratio:

$$\text{Contrast Ratio (CR)} = \frac{\text{Luminance When LCD is White}}{\text{Luminance When LCD is Black}}$$

Contrast Ratio is measured in optimum common electrode voltage

Note4: Definition of response time:

The temperature condition is ambient temperature.

The response time is defined as the LCD optical switching time interval between “White” state and “Black” state. Rise time (T_r) is the time between photo detector output intensity changed from 10% to 90%. And fall time (T_f) is the time between photo detector output intensity changed from 90% to 10%. Refer to the figure below:

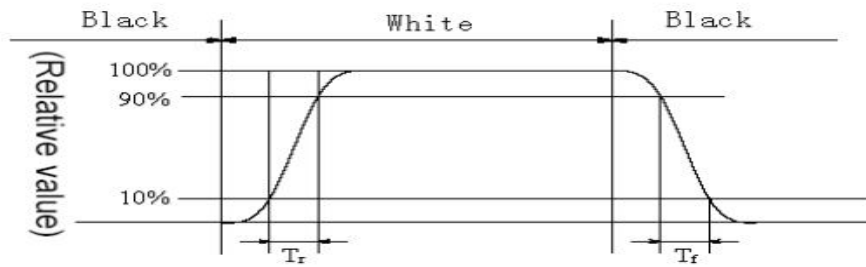

Note5: Definition of color chromaticity (CIE1931) Color coordinates measured at the center point of the LCD.

Note 6: Contrast ratio against temperature CR defines the allowed contrast reduction at the defined temperature based on the CR at room temperature. For example:

$$CR = (CR@25^{\circ}C - CR@85^{\circ}C) / CR@25^{\circ}C \times 100\%$$

Note7: Definition of Luminance Uniformity

The luminance uniformity is calculated by using following formula.

$$\text{Luminance uniformity (Lu)} = \frac{\text{Minimum luminance from ① to ⑨}}{\text{Maximum luminance from ① to ⑨}}$$

Luminance is measured at the 9 points shown below.

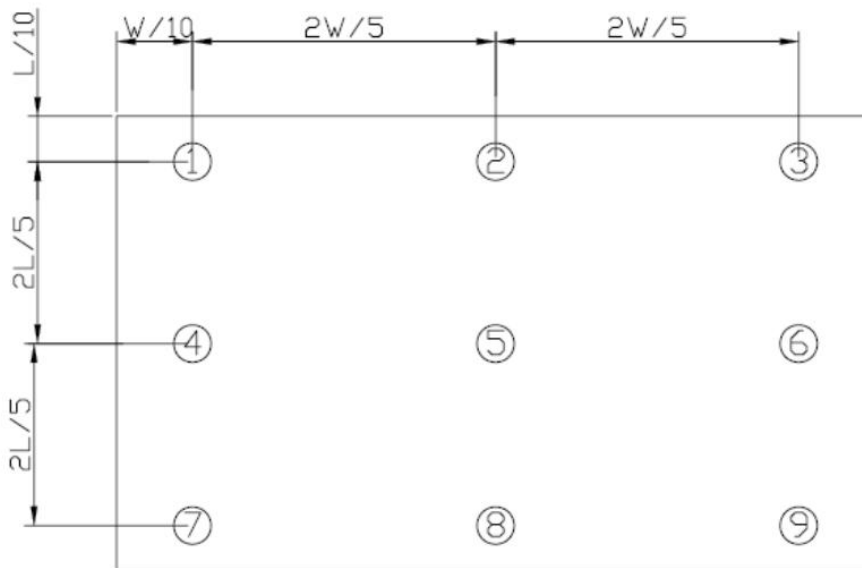

Note8: Definition of Luminance Measure the luminance at white state at the center point.

Note9: The value % base on CR measurement method, dB base on JEIDA method



8. Reliability Test

8.1 Content of Reliability Test

NO.	Test Item	Test condition	Criterion
1	High Temperature Storage	85°C, 500H RH<=45% Restore 2H at 25°C, non-operation	Note 1 IEC 60 068 - 2 - 2Bb
2	Low Temperature Storage	-40°C±3°C, 500H Restore 2H at 25°C, non-operation	Note 1 IEC 60 068 - 2 - 1Ab
3	High Temperature Operation	85°C±2°C, 500H RH<=45% Restore 2H at 25°C, operation	Note 1 IEC 60 068 - 2 - 2Bb Note 7
4	Low Temperature Operation	-30°C±3°C, 500H Restore 2H at 25°C, operation	Note 1 IEC 60 068 - 2 - 1Ab
5	High Temperature & Humidity Operation	60°C±2°C, 90±2%RH 500H operation	Note 1 IEC 60 068 - 2 - 3Ca
6	Thermal Shock	-30°C→ change→+85°C 30min 30s 30min, 100cycle, Non-operation	Note 1 IEC 60 068 - 2 - 14Nb
7	Vibration Test	Sweep: 10Hz ~50Hz~10Hz 2G 2 hours for each direction of X.Y.Z (6 hours for total) Non-operation	Note 2 IEC 60 068 - 2 - 6Fc
8	Package vibration Test	Ranmdom vibration 0.015G*G/Hz from 5-200Hz, -6db/Octave from 200 -500Hz 2 hours for each direction of X.Y.Z (6 hours for total)	
9	Package Drop Test	Hight : 60 cm 1 corner, 3 edges, 6 surfaces	
10	ESD	Air discharge: C=150pF±10%, R=330Ω±10%, 5 point/panel Air: +/-15KV, 5 times Contact: +/-8KV, 5 times	GB/T17626(IEC61000)/ ISO10605

Notes:

1. The test result shall be evaluated after the sample has been left at room temperature and humidity for 2 hours without load. No condensation shall be accepted. The sample will not be accepted if appear these defects:

- 1) Air bubble in the LCD
- 2) Seal leak



- 3) Non-display
 - 4) Missing segments
 - 5) Glass crack
-
2. Each test item applies for a test sample only once. The test sample can't be used again in any other test item.
 3. For Damp Proof Test, Pure water (Resistance $> 10M \Omega$) should be used.
 4. In case of malfunction defect caused by ESD damage, if it would be recovered to normal state after resetting, it would be judged as a good part.
 5. In the test of High Temperature Operation and High Temperature & Humidity Operation. The operation temperature is the surface temperature of module
 6. We will consult with our customers, if appearing problems during the reliability test.
 7. LED forward current should follow the De-rating curve.



9. Mechanical Drawing

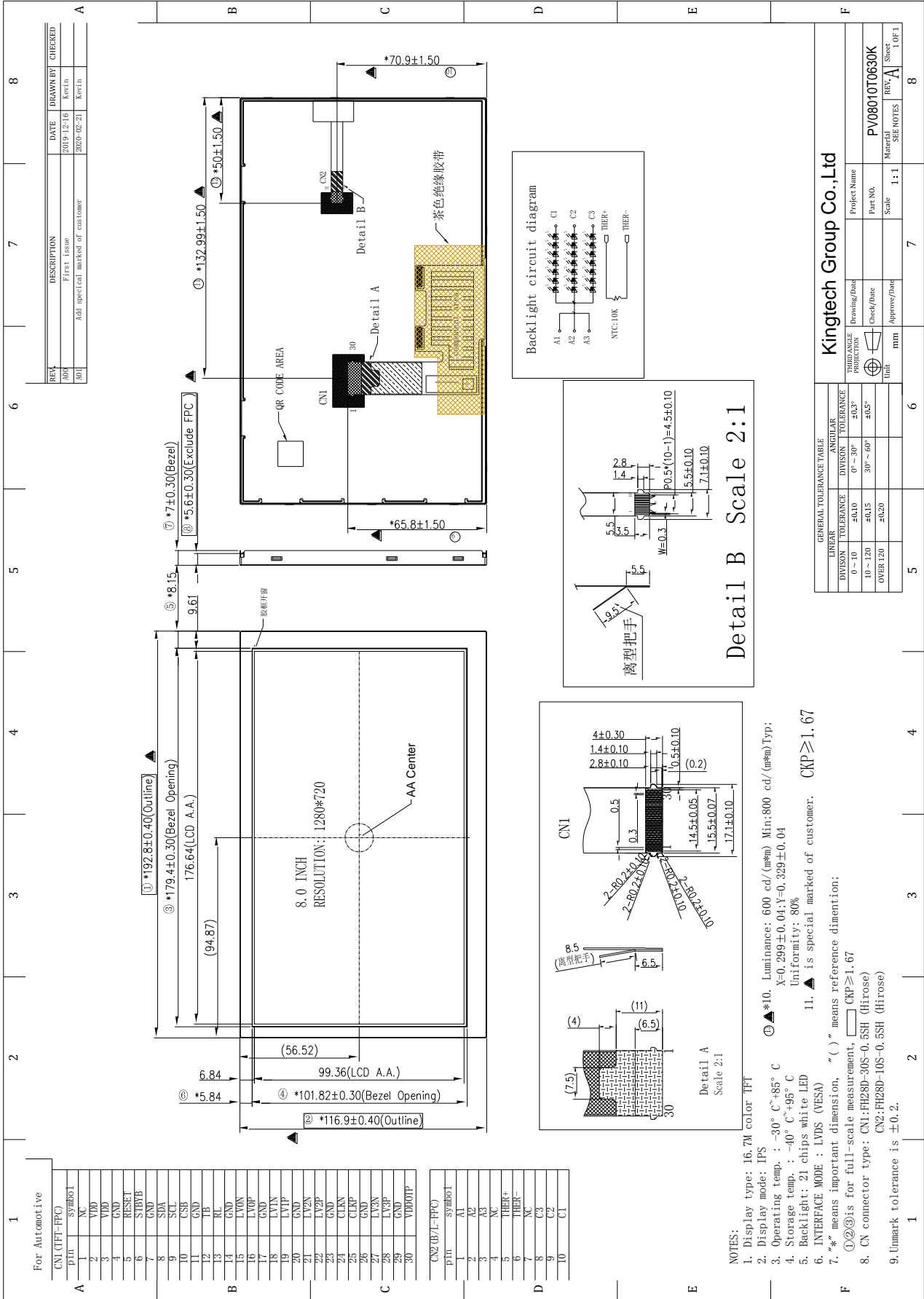



10. Product Inspection Criteria

10.1 Incoming Inspection

The customer shall inspect the modules within twenty calendar days of the delivery date (the inspection period) at its own cost. The result of the inspection (acceptance or rejection) shall be recorded in writing, and a copy of this writing will be promptly sent to the seller. If the results of the inspecting from buyer does not send to the seller within twenty calendar days of the delivery date. The modules shall be regarded as accepted.

Should the customer fail to notify the seller within the inspection period, the buyer's right to reject the modules shall be lapsed and the modules shall be deemed to have been accepted by the buyer

10.2 Inspection Sampling Method

- 10.2.1 Lot size: Quantity per shipment lot per model
- 10.2.2 Sampling type: Normal inspection, Single sampling
- 10.2.3 Inspection level: II
- 10.2.4 Sampling table: MIL-STD-105D
- 10.2.5 Acceptable quality level (AQL)
 - Major defect: AQL=0.65
 - Minor defect: AQL=1.00

10.3 Inspection Conditions

10.3.1 Ambient conditions:

- a. Temperature: Room temperature $25 \pm 5^{\circ}\text{C}$
- b. Humidity: $(60 \pm 10) \% \text{RH}$
- c. Illumination: Single fluorescent lamp non-directive (300 to 700 Lux)

10.3.2 Viewing distance

The distance between the LCD and the inspector's eyes shall be at least $35 \pm 5\text{cm}$.

10.3.3 Viewing Angle U/D: $45^{\circ} / 45^{\circ}$, L/R: $45^{\circ} / 45^{\circ}$

10.3.4 Definition of LCD zone (with front bezel)

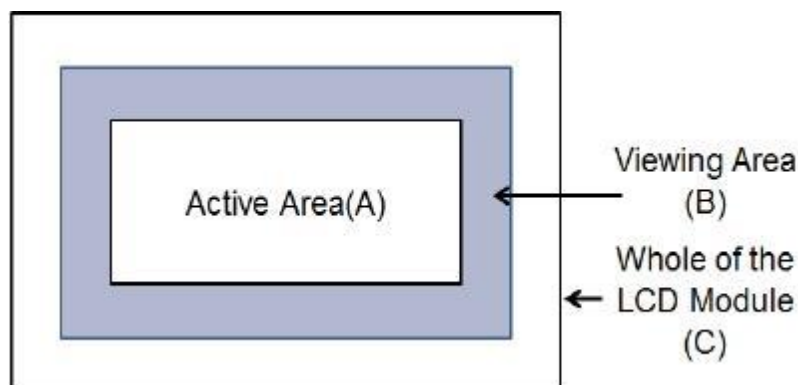

A-zone: The inside of the Active Area (as defined on the product drawing)

B-zone: The inside of the Viewing Area which is between A-zone and the metal frame (defined on the product drawing if no up metal frame)

C-zone: Whole of the LCD Module except the zone A and B. (Including FPC& Metal Frame & backside of the LCD Module)



10.4 Cosmetic Inspection Criteria

10.4.1 Major defect

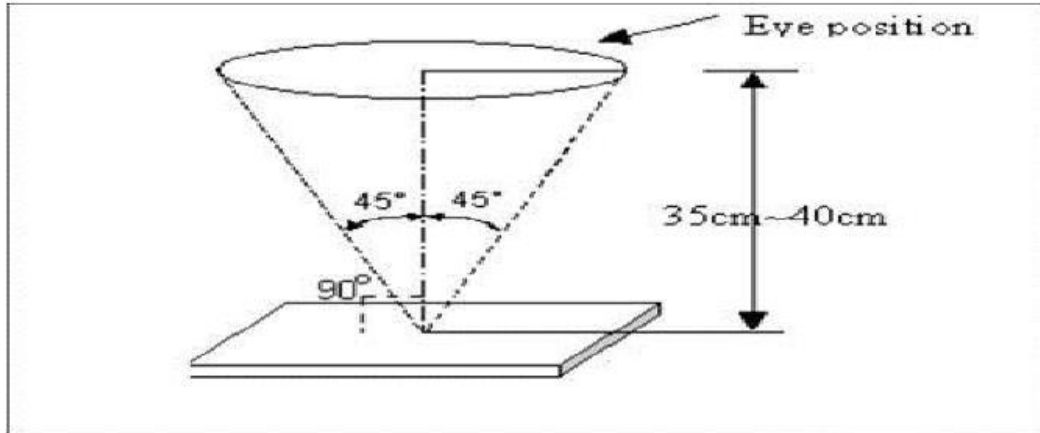

No	Items to be inspected	Inspection standard
1	All functional defects	1) No display 2) Abnormal display 3) Short circuit 4) line defect
2	Crack	Glass Crack

10.4.2 Minor defect

No.	Inspection Item	Inspection Standards	Acceptable Qty.	Applied Zone	Inspection Mode	Note
1	Bright spots	$\varphi \leq 0.2$	Ignore 3 None	A	Light-on	$\varphi = (x+y) / 2$
		$0.2 < \varphi \leq 0.4$				
		$0.40 < \varphi$				
2	Dark spots	$\varphi \leq 0.2$	Ignore 3 None	A/B	Light-on	$\varphi = (x+y) / 2$
		$0.2 < \varphi \leq 0.4$				
		$0.40 < \varphi$				



		W>0.25	None			
5	Lints & Scratches	W≤0.05 and L≤5.0	Ignore	A/B	Light-on Light-off	$\varphi = (x+y) / 2$
		0.05<W≤0.10 and L≤5.0	2			
		0.10< W or L>5.0	None			
6	Dent\Bubble	$\varphi \leq 0.2$	Ignore	A/B	Light-on Light-off	$\varphi = (x+y) / 2$
		$0.2 < \varphi \leq 0.4$	3			
		$0.40 < \varphi$	None			
7	Dirty\Dust	Those wiped out easily are acceptable				
8	Electrical Dot Defect	Inspection pattern: Full white, Full black, Red, green and blue screens		A	Light-on	
		Black dot defect	3			
		Bright dot defect	0			
		Total Dot	3			
9	Glass defect	1. Corner Fragment:				
		X≤3mm	Ignore	A/B	Light-off	
		Y≤3mm	T : Glass thickness			
		Z≤T	X: Length Y: Width Z: thickness			
		2. Side Fragment:				
		X≤6.0mm	Ignore	A/B	Light-off	
		Y ≤1mm	T : Glass thickness			
		Z≤T	X: Length Y: Width Z: thickness			
11	Mura	Visible through ND 5% at full black pattern	None	A	Light-on	

Note1: Dot defect is defined as the defective area of the dot area is larger than 50% of the dot area.

Note2: Polarizer bubble is defined as the bubble appears on active display area. the defect of polarizer bubble shall be ignored if the polarizer bubble appears on the outside of active display area.

Note3: If any problems or doubts arise with the LCD, the customer and supplier will cooperate and make efforts to solve it with mutual confidence and respect. Issues which are not defined in these criteria shall be discussed with both parties, customer and supplier, for a better solution.



Note4: The distance between black dot defects should be more than 5mm.

11.Packing Instruction

Packing information(TBD)

Module label information(TBD)



12. Precautions for Use of LCD Module

12.1 Handling Precautions

12.1.1 The display panel is made of glass. Do not subject it to mechanical shock by dropping it, etc.

12.1.2 If the display panel is damaged and the liquid crystal fluid inside it leaks out be sure not to get any in your mouth. If the fluid comes out and contact with your skin or clothes promptly wash it off using soap and water.

12.1.3 Do not apply excessive force to the display surface or the bezel since this may cause the color tone to vary.

12.1.4 The polarizer covering the display surface of the LCD module is soft and easily scratched. Handle the polarizer carefully.

12.1.5 If the display surface is contaminated, breathe on the surface and gently wipe it with a soft dry cloth. If it is still not completely clear use a moist cloth with one of the following solvents:

- Isopropyl alcohol
- Ethyl alcohol

Solvents other than those mentioned above may damage the polarizer.

Specifically, do not use the following:

- Water
- Ketone
- Aromatic solvents

12.1.6 Do not attempt to disassemble the LCD Module.

12.1.7 If the logic circuitry is powered off, do not apply the input signals.

12.1.8 To prevent destruction of the module by static electricity, be careful to maintain an optimum work environment.

12.1.8.1 Be sure to ground your body when handling the LCD Modules.

12.1.8.2 Tools used for assembly, such as soldering irons, must be properly grounded.

12.1.8.3 To reduce the amount of static electricity generated, do not conduct assembly or other work under very low humidity conditions.

12.1.8.4 The LCD Module is covered with a film to protect the display surface.

Be careful when peeling off this protective film since static electricity may be generated.

12.2 Storage precautions

12.2.1 When storing the LCD modules avoid exposure to direct sunlight or to the light of fluorescent lamps.

12.2.2 The LCD modules should be stored within the rated storage temperature range. If the LCD modules will be stored for a long time, the recommend condition is:

Temperature: 15 ~ 35 degree C (or at least Temp. 10 ~ 40 degree C / Humidity 25% ~ 75%), for National Std. recommendation

12.2.3 The LCD modules should be stored in a room without acid, alkali or other harmful gases.



12.3 Transportation Precautions

The LCD modules should not be dropped or subject to violent mechanical shock during transportation. And they should avoid excessive pressure, water, high humidity and direct sunlight.

13. Appendix table

SDNT1005X103□3380□TF R-T对照表

温度 (°C)	25°C 阻值 (KΩ)	B值	阻值 (KΩ)	温度 (°C)	25°C 阻值 (KΩ)	B值	阻值 (KΩ)	温度 (°C)	25°C 阻值 (KΩ)	B值	阻值 (KΩ)	温度 (°C)	25°C 阻值 (KΩ)	B值	阻值 (KΩ)
-30	10	3380	119.52	8	10	3380	19.70	46	10	3380	4.72	84	10	3380	1.48
-29	10	3380	113.30	9	10	3380	18.90	47	10	3380	4.57	85	10	3380	1.44
-28	10	3380	107.45	10	10	3380	18.13	48	10	3380	4.42	86	10	3380	1.40
-27	10	3380	101.93	11	10	3380	17.39	49	10	3380	4.27	87	10	3380	1.37
-26	10	3380	96.73	12	10	3380	16.69	50	10	3380	4.13	88	10	3380	1.33
-25	10	3380	91.83	13	10	3380	16.02	51	10	3380	4.00	89	10	3380	1.29
-24	10	3380	87.21	14	10	3380	15.39	52	10	3380	3.87	90	10	3380	1.26
-23	10	3380	82.85	15	10	3380	14.78	53	10	3380	3.75	91	10	3380	1.23
-22	10	3380	78.73	16	10	3380	14.20	54	10	3380	3.63	92	10	3380	1.19
-21	10	3380	74.85	17	10	3380	13.64	55	10	3380	3.51	93	10	3380	1.16
-20	10	3380	71.18	18	10	3380	13.11	56	10	3380	3.40	94	10	3380	1.13
-19	10	3380	67.71	19	10	3380	12.61	57	10	3380	3.30	95	10	3380	1.10
-18	10	3380	64.43	20	10	3380	12.12	58	10	3380	3.19	96	10	3380	1.07
-17	10	3380	61.33	21	10	3380	11.66	59	10	3380	3.09	97	10	3380	1.05
-16	10	3380	58.40	22	10	3380	11.22	60	10	3380	3.00	98	10	3380	1.02
-15	10	3380	55.62	23	10	3380	10.79	61	10	3380	2.91	99	10	3380	0.99
-14	10	3380	53.00	24	10	3380	10.39	62	10	3380	2.82	100	10	3380	0.97
-13	10	3380	50.51	25	10	3380	10.00	63	10	3380	2.73	101	10	3380	0.95
-12	10	3380	48.16	26	10	3380	9.63	64	10	3380	2.65	102	10	3380	0.92
-11	10	3380	45.93	27	10	3380	9.27	65	10	3380	2.57	103	10	3380	0.90
-10	10	3380	43.81	28	10	3380	8.93	66	10	3380	2.49	104	10	3380	0.88
-9	10	3380	41.81	29	10	3380	8.61	67	10	3380	2.42	105	10	3380	0.85
-8	10	3380	39.91	30	10	3380	8.30	68	10	3380	2.35	106	10	3380	0.83
-7	10	3380	38.11	31	10	3380	8.00	69	10	3380	2.28	107	10	3380	0.81
-6	10	3380	36.40	32	10	3380	7.71	70	10	3380	2.21	108	10	3380	0.79
-5	10	3380	34.77	33	10	3380	7.43	71	10	3380	2.15	109	10	3380	0.77
-4	10	3380	33.23	34	10	3380	7.17	72	10	3380	2.09	110	10	3380	0.76
-3	10	3380	31.77	35	10	3380	6.92	73	10	3380	2.03	111	10	3380	0.74
-2	10	3380	30.38	36	10	3380	6.67	74	10	3380	1.97	112	10	3380	0.72
-1	10	3380	29.05	37	10	3380	6.44	75	10	3380	1.91	113	10	3380	0.70
0	10	3380	27.80	38	10	3380	6.22	76	10	3380	1.86	114	10	3380	0.69
1	10	3380	26.60	39	10	3380	6.00	77	10	3380	1.80	115	10	3380	0.67
2	10	3380	25.46	40	10	3380	5.80	78	10	3380	1.75	116	10	3380	0.65
3	10	3380	24.38	41	10	3380	5.60	79	10	3380	1.70	117	10	3380	0.64
4	10	3380	23.35	42	10	3380	5.41	80	10	3380	1.66	118	10	3380	0.62
5	10	3380	22.37	43	10	3380	5.23	81	10	3380	1.61	119	10	3380	0.61
6	10	3380	21.44	44	10	3380	5.05	82	10	3380	1.57	120	10	3380	0.60
7	10	3380	20.55	45	10	3380	4.88	83	10	3380	1.52	125	10	3380	0.53

