



承认编码: CR _____

TFT LCD MODULE
1.54 inch 240RGB*240DOTS

MODULE NUMBER: PV015400KLD24C

REVISION: V03

Customer Approval:

- Approved For Specifications
- Approved For Specifications & Sample**

Prepared by	Checked by	Approved by
David		



Index

Contents	Page
1. LCM Specification	4
2. Mechanical Specification...	5
3. Pin Descriptions	6
4. Electrical Units.....	7
5. AC Characteristics.....	9
6. Power ON/OFF Sequence.....	11
7. Optical Specifications	13
8. Reliability Test Items... ..	16
9. Handling Precautions... ..	17
10. QC.....	20



1. LCM Specification

1.1 Description

PV015400KLD24C is a transmissive type color active matrix liquid crystal display(LCD) which uses amorphous thin film transistor(TFT) as switching devices. This product is composed of a TFT LCD panel, a drive IC, a FPC and a LED-backlight unit. The active display area is 1.54 inches diagonally measured and the native resolution is 240*RGB*240. Features of this product are listed in the following table.

1.2 Functions & Features

Table 1.1 Module Functions & Features

Parameter	Value	Unit
LCD Mode	TFT/Transmissive	-
Color Depth	262 K	-
Display Resolution	240RGB*240	pixels
Module Size	33.72(H)*31.52(W)*1.85(T)(Exclude FPC)	mm
Active Area (A.A)	27.72(H)*27.72(W)	mm
Pixel Arrangement	RGB-stripe	-
Viewing Direction	All O' clock	
Display Mode	Normally black	
LCD Controller/Driver	ST7789V	-
IC Package Type	COG	-
Interface	8/9-bits MPU	-
Power Supply Voltage	2.8~3.6	V
LCM Brightness		cd /m ²
Back-light	White LED*3	PCS



2. Mechanical Specification

Dimensions: 31.52±0.15 BL, 30.12 TFT/CF, 29.72 POL, 27.72 AA, 1.54" IPS 262K, DOTS: 240/240, 33.72±0.15 BL, 10.52, 4.53, 4.00, 7.50, 34.86, 1.85±0.05Δ, 7.87±0.5, 10.07±0.5, 1.0max, 0.4MAX, 1:0.2mm, OK-03M034-04, 点阵数, 焊盘高度, FPCC凸出处, 焊盘高度 0.4MAX, 注意避空, 焊盘高度 1:0.2mm

PIN	NAME
1	GND
2	/RESET
3	GND
4	DB8
5	DB7
6	DB6
7	DB5
8	DB4
9	DB3
10	DB2
11	DB1
12	DB0
13	IM1
14	/RD
15	/WR
16	RS
17	/CS
18	IOVCC
19	FMARK
20	VCI
21	GND
22	LEDA
23	LEDK
24	GND

弯折示意图
展开出货

IM1	system interface data bus
0	8 BIT
1	8 BIT
DB0-DB8	DB0-DB8

LEDK → LEDA

U=3.2V I=60MA

Display Type	TFT(Normally Black/TRANSMISSIVE)
Display Resolution	DOTS: 240RGB*240
Viewing Angle	ALL
LCD Controller/Driver	ST7789V
Logic Voltage	2.8V
Operation Temperature	-20°C ~ 70°C
Storage Temperature	-30°C ~ 80°C
Backlight Spec.	White LED (3 parallels connect) / Δ I= 60MA VF=3.2V

REV.	DESCRIPTION	DATE	APPROVE:
1.2	修改背光, 取消改为0.4T	2016.08.01	敖玮
1.1	修改背光	2016.08.01	
1.0	新制订	2015.12.10	

Kingtech Group Co.,Ltd	
TITLE:	PV015400KLD24C
DOC. NO.	
PART NO.	
REV.	1.2
SHEET	1 OF 1
UNITS:	mm
SCALE	1:1



3. Pin Descriptions

Pin No.	Symbol	I/O	Functional	Remark
1	GND	P	System ground.	
2	RESET	I	Reset signal pin.	
3	GND	P	System ground.	
4~12	DB8~DB0	I/O	Data bus	
13	IM1	I	Select the MCU interface mode When IM1=0 : 8-bit MCU When IM0=1 : 9-bit MCU	
14	RD	I	8080- I system (RDX): Serves as a read signal and MCU read data at the rising edge.	
15	WR	I	8080- I system (WRX): Serves as a write signal and writes data at the rising edge.	
16	RS	I	8080- I system (RSX): This pin is used to select "Data or Command" in the parallel interface. When DCX = 1, data is selected. When DCX = 0, command is selected.	
17	CS	I	Chip select input pin	
18	IOVCC	P	Logic Power supply: 1.65~3.3V	
19	FMARK	O	Tearing effect output pin to synchronize MPU to frame writing, activated by S/W command. When this pin is not activated, this pin is low.	
20	VCI	P	Power supply, 2.5~3.3V	
21	GND	P	System ground.	
22	LEDA	P	LED Power supply +	
23	LEDK	P	LED Power supply -	
24	GND	P	System ground.	

说明：接口为8/9-bit MCU 接口可选，默认为8-bit MCU 接口。



4. Electrical Units

4.1 Absolute Maximum Ratings

The absolute maximum ratings are list on Table 4.1. When used out of the absolute maximum ratings, the LCM may be permanently damaged. Using the LCM within the following electrical characteristics limit is strongly recommended for normal operation. If these electrical characteristic conditions are exceeded during normal operation, the LCM will malfunction and cause poor reliability.

Table 4.1 Module Absolute Maximum Ratings

Item	Symbol	Unit	Value	Note
Power Supply Voltage (1)	Vdd	V	-0.3 to +4.6	
Power Supply Voltage (2)	VGH ~ VSS	V	-0.3 to +21	
Power Supply Voltage (3)	VSS ~ VGL	V	0 to -12.5	
Operating Temperature	Top	°C	-20 to +70	
Storage Temperature	Tst	°C	-30 to +80	
Operating Humidity	Hop	%(RH)	85	

(VSS=0V)

4.2 Electrical characteristics (Ta=25°C)

Table 4.2:DC Characteristic (Vcc = 3.0 ~ 3.6V)

Item		Symbol	Condition	Min.	Type.	Max.	Unit
Supply Voltage	Power	VCI	---	2.5	2.8	3.3	V
	Logic	IOVCC	---	1.65	2.8	3.3	V
Input Voltage	H level	V _{IH}	---	0.7V _{dd}	---	V _{dd}	V
	L level	V _{IL}		0	---	0.3V _{dd}	
Current Consumption		I _{DD}	With internal voltage generation; VDD=2.8V Tamb=2 5°C;	8	9	--	mA



4.3 Back-light Specification

Table 4.3 Back-light Characteristics

Item	Symbol	Conditions	Min.	Type.	Max.	Unit
Supply Voltage	VF	Only Backlight	2.7	3.2	9.4	V
Supply Current	IF		60			mA
Average Brightness	IV	Backlight Current IF=60mA	-	3500	-	Cd/m ²
CIE Color Coordinate (Without LCD)	X	Backlight Current IF=60mA	0.26	--	0.31	-
	Y		0.26	--	0.31	
Uniformity	B	Backlight Current IF=60mA	--	80%	-	%
Color	White					
Life Time	—		20000	-	-	Hr

Note: 3 LED in parallels.



5. AC Characteristics

5.1 Parallel 9/8-bit Interface Timing Characteristics

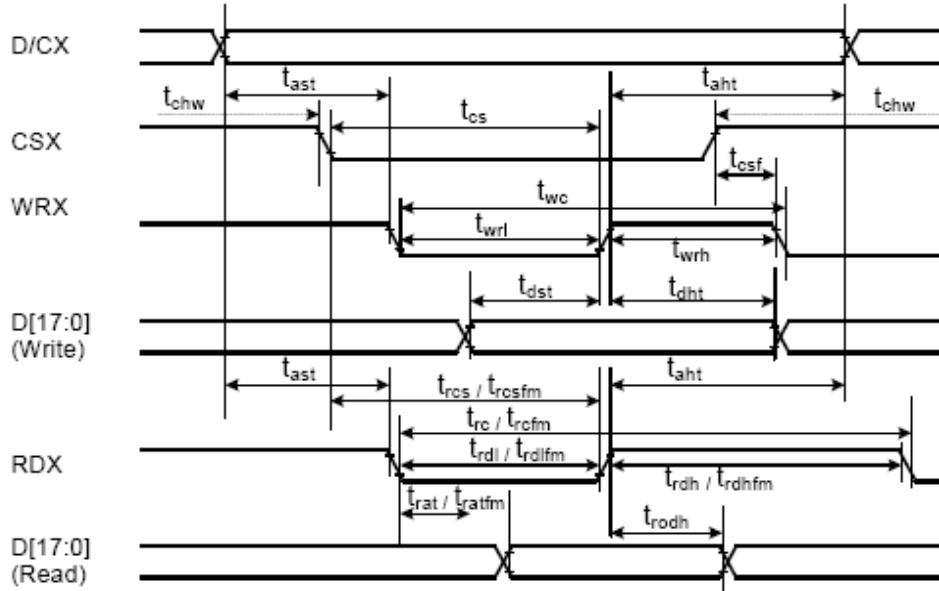

Signal	Symbol	Parameter	min	max	Unit	Description
DCX	t _{ast}	Address setup time	0	-	ns	
	t _{ah}	Address hold time (Write/Read)	0	-	ns	
CSX	t _{chw}	CSX "H" pulse width	0	-	ns	
	t _{cs}	Chip Select setup time (Write)	15	-	ns	
	t _{rcs}	Chip Select setup time (Read ID)	45	-	ns	
	t _{rcsfm}	Chip Select setup time (Read FM)	355	-	ns	
	t _{csf}	Chip Select Wait time (Write/Read)	10	-	ns	
WRX	t _{wc}	Write cycle	66	-	ns	
	t _{wrh}	Write Control pulse H duration	15	-	ns	
	t _{wrl}	Write Control pulse L duration	15	-	ns	
RDX (FM)	t _{rcfm}	Read Cycle (FM)	450	-	ns	
	t _{rdhfm}	Read Control H duration (FM)	90	-	ns	
	t _{rdlfm}	Read Control L duration (FM)	355	-	ns	
RDX (ID)	t _{rc}	Read cycle (ID)	160	-	ns	
	t _{rdh}	Read Control pulse H duration	90	-	ns	
	t _{rdl}	Read Control pulse L duration	45	-	ns	
D[17:0], D[15:0], D[8:0], D[7:0]	t _{dst}	Write data setup time	10	-	ns	For maximum CL=30pF For minimum CL=8pF
	t _{dht}	Write data hold time	10	-	ns	
	t _{rat}	Read access time	-	40	ns	
	t _{ratfm}	Read access time	-	340	ns	
	t _{rod}	Read output disable time	20	80	ns	

Note: T_a = -30 to 70 °C, VDDI=1.65V to 3.3V, VCI=2.5V to 3.3V, VSS=0V

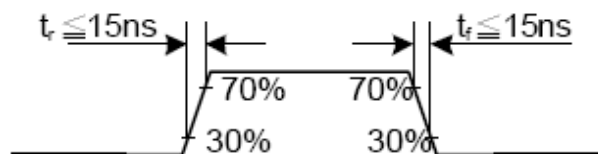



CSX timings :

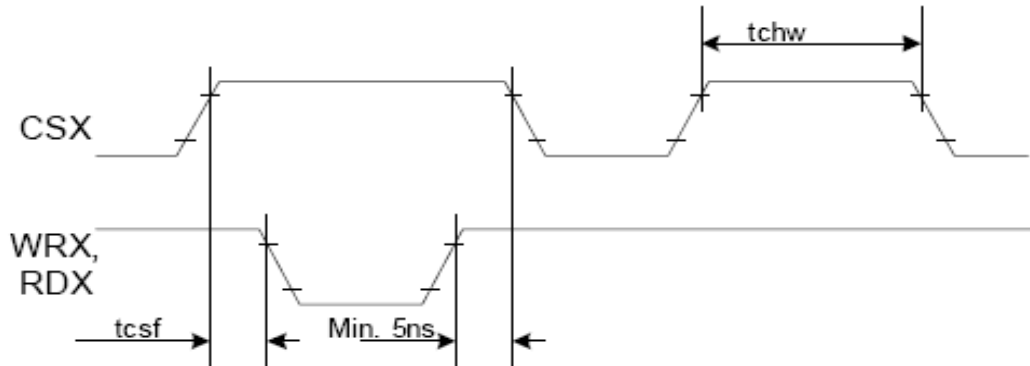

Note: Logic high and low levels are specified as 30% and 70% of VDDI for Input signals.

Write to read or read to write timings:

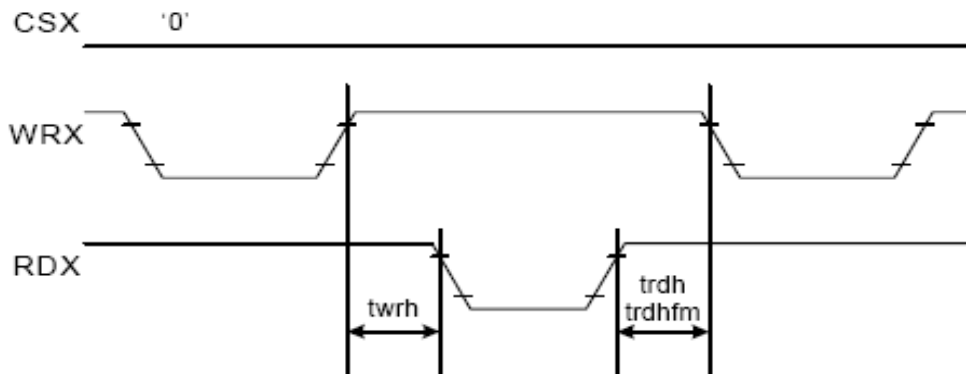

Note: Logic high and low levels are specified as 30% and 70% of VDDI for Input signals.



6. Power ON/OFF Sequence

VDDI and VCI can be applied in any order.

VCI and VDDI can be powered down in any order.

During power off, if LCD is in the Sleep Out mode, VCI and VDDI must be powered down minimum 120msec after RESX has been released.

During power off, if LCD is in the Sleep In mode, VDDI or VCI can be powered down minimum 0msec after RESX has been released. CSX can be applied at any timing or can be permanently grounded. RESX has priority over CSX.

Note 1: There will be no damage to the display module if the power sequences are not met.

Note 2: There will be no abnormal visible effects on the display panel during the Power On/Off Sequences.

Note 3: There will be no abnormal visible effects on the display between end of Power On Sequence and before receiving Sleep Out command. Also between receiving Sleep In command and Power Off Sequence.

Note 4: If RESX line is not held stable by host during Power On Sequence as defined in Sections 12.1 and 12.2, then it will be necessary to apply a Hardware Reset (RESX) after Host Power On Sequence is complete to ensure correct operation. Otherwise function is not guaranteed.

6.1. Case 1 – RESX line is held High or Unstable by Host at Power ON

If RESX line is held High or unstable by the host during Power On, then a Hardware Reset must be applied after both VCI and VDDI have been applied – otherwise correct functionality is not guaranteed. There is no timing restriction upon this hardware reset.

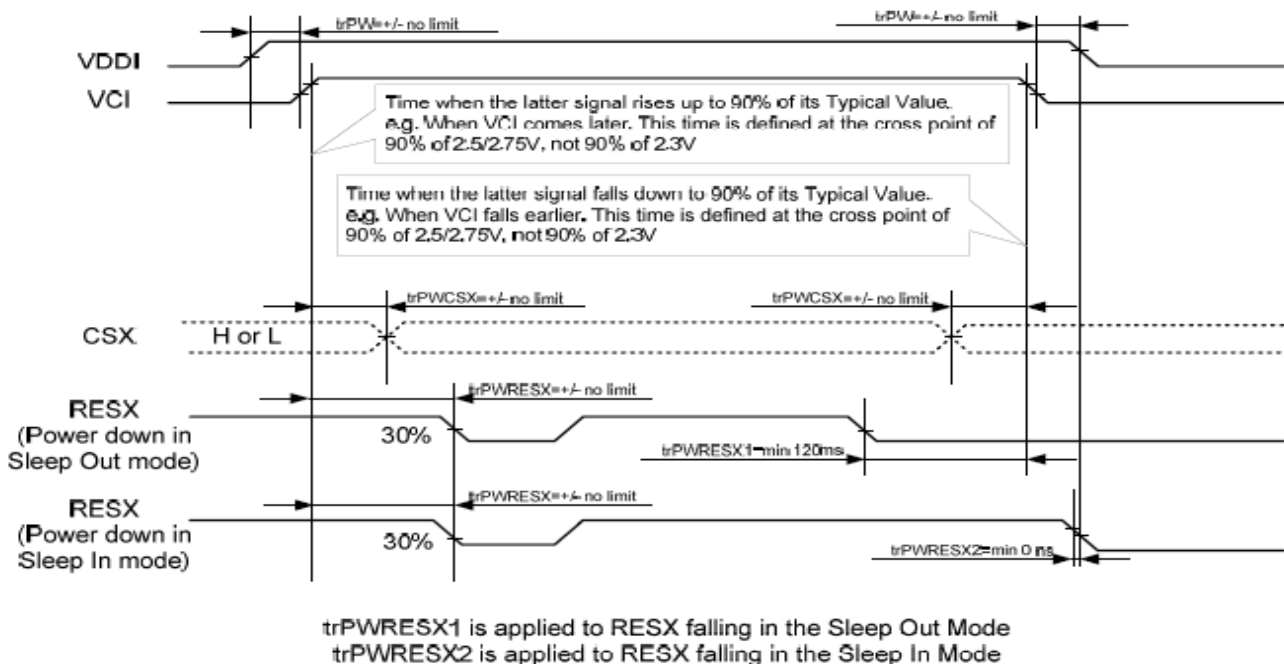



6.2. Case 2 – RESX line is held Low by Host at Power ON

If RESX line is held Low (and stable) by the host during Power On, then the RESX must be held low for minimum 10µsec after both VCI and VDDI have been applied.

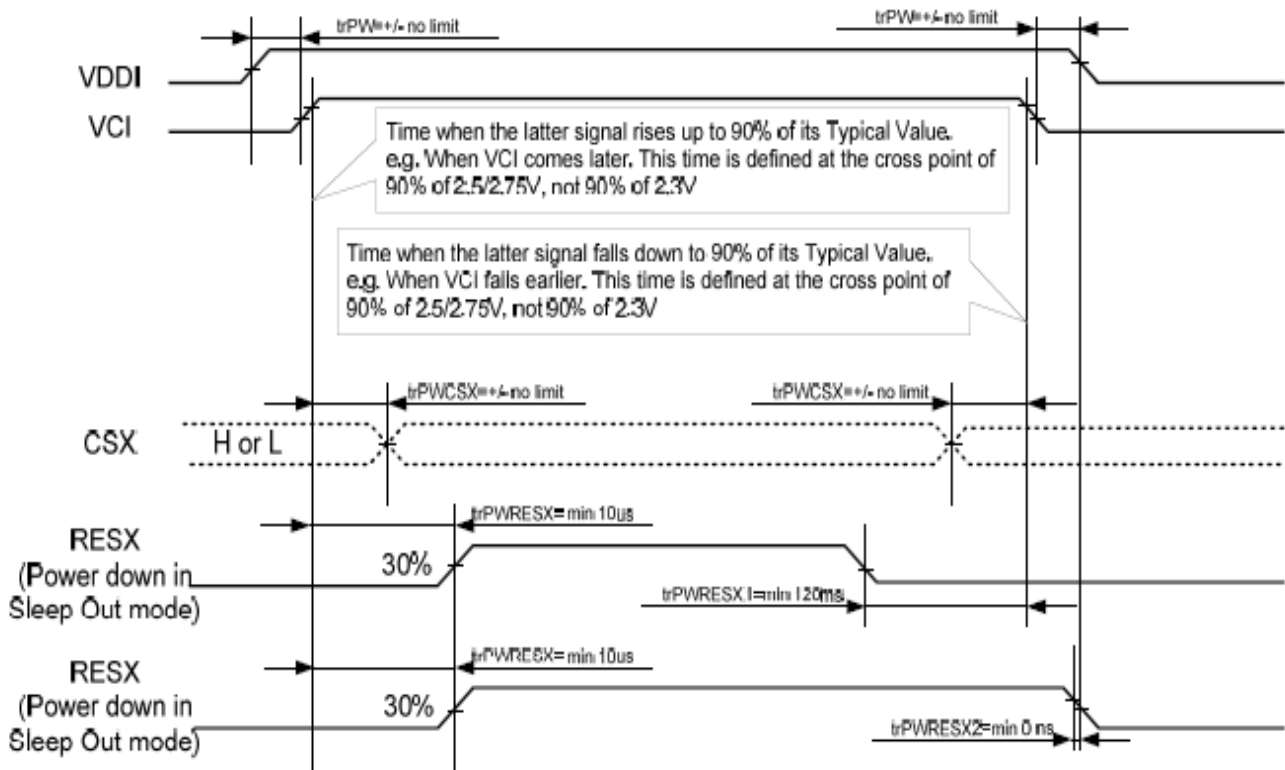

trPWRESX1 is applied to RESX falling in the Sleep Out Mode
trPWRESX2 is applied to RESX falling in the Sleep In Mode

Note 1: Unless otherwise specified, timings herein show cross point at 50% of signal power level.



7. Optical Specifications

7.1 Overview

The test of Optical specifications shall be measured in a dark room(ambient luminance ≤ 1 lux and temperature = 25±2°C) with the equipment of Luminance meter system (Topcon SR-UL1R and Westar TRD-100A) and test unit shall be located at an approximate distance 50cm from the LCD surface at a viewing angle of θ and Φ equal to 0°. The center of the measuring spot on the Display surface shall stay fixed.

The backlight should be operating for 30 minutes prior to measurement.*3): Only Color Filter glass

7.2 Optical Specifications

Parameter		Symbol	Condition	Min.	Typ.	Max.	Unit	Remark
Threshold Voltage		Vsat		4.1	4.3	4.5	V	Fig.1
		Vth		1.6	1.8	2.0	V	
Viewing Angle	Horizontal	Θ_3	CR>10		80		°	Note 1
		Θ_9			80		°	
	Vertical	Θ_{12}			80		°	
		Θ_6			80		°	
Contrast Ratio		CR	$\Theta = 0^\circ$		900			Note 2
Luminance		cd/m ²	$\Theta = 0^\circ$		450		lm	Note 3
Uniformity		%	$\Theta = 0^\circ$					Note 4
NTSC		%	$\Theta = 0^\circ$		50			
Reproduction Of color	Red	Rx	$\Theta = 0^\circ$		TBD			Note 4 *Module
		Ry			TBD			
	Green	Gx			TBD			
		Gy			TBD			
	Blue	Bx			TBD			
		By			TBD			
White		Wx	$\Theta = 0^\circ$		TBD			
		Wy			TBD			
Response Time		Tr+Tf	$\Theta = 0^\circ$		35	50	ms	Note 5

Note:

1. Viewing angle is the angle at which the contrast ratio is greater than 10. The viewing are determined for the horizontal or 3, 9 o'clock direction and the vertical or 6, 12 o'clock direction with respect to the optical axis which is normal to the LCD surface (See FIG.1).
2. Contrast measurements shall be made at viewing angle of $\Theta = 0^\circ$ and at the center of the LCD surface. Luminance shall be measured with all pixels in the view field set first to white, then to the dark (black) state. (See FIG. 1) Luminance Contrast Ratio (CR) is defined mathematically.

$$CR = \frac{\text{Luminance when displaying a white raster}}{\text{Luminance when displaying a black raster}}$$



3. Surface luminance is the center point across the LCD surface 50cm from the surface with all pixels displaying white. This measurement shall be taken at the locations shown in FIG. 2.

4. Uniformity measurement shall be taken at the locations shown in FIG. 2&3, for a total of the measurements per display, measure surface luminance of these nine points across the LCD surface 50cm from the surface with all pixels displaying white.

$$\text{Uniformity} = \frac{\text{Min Luminance of 9 points}}{\text{Max Luminance of 9 points}} \times 100\%$$

5. The color chromaticity coordinates specified in Table1 shall be calculated from The spectral data measured with all pixels first in red, green, blue and white. Measurements shall be made at the center of the Module.

6. The electro-optical response time measurements shall be made as FIG.4 by switching the "data" input signal ON and OFF.

The times needed for the luminance to change from 10% to 90% is T_r and 90% to 10% is T_f .

Figure 1. The definition of V_{th} & V_{sat}

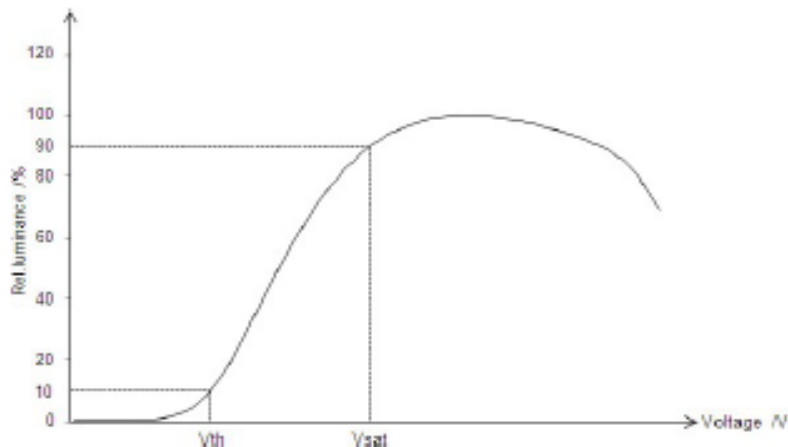

Figure 2. Measurement Set Up

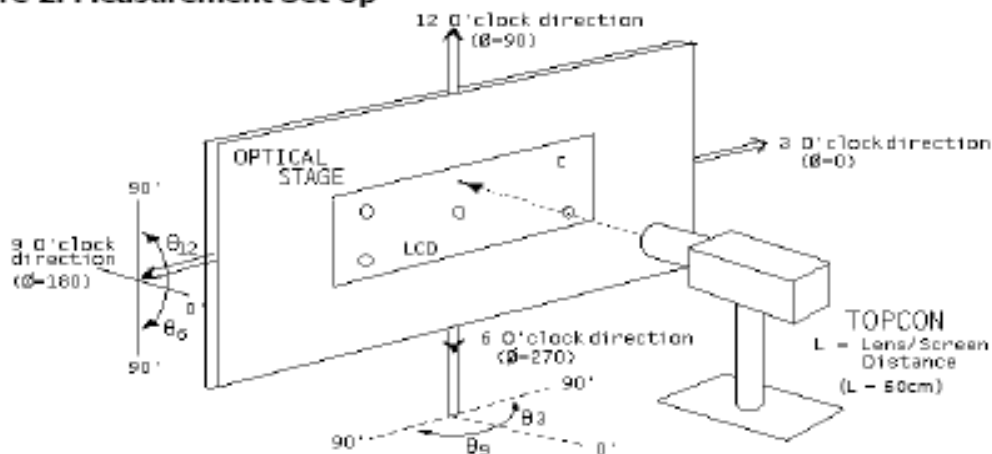



Figure 3. Uniformity Measurement Locations

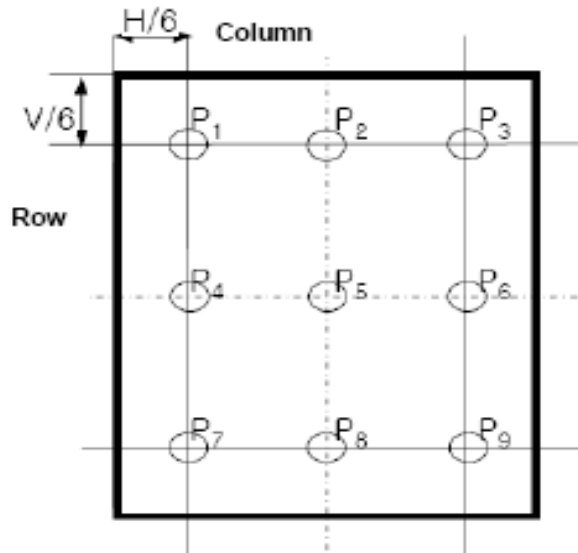
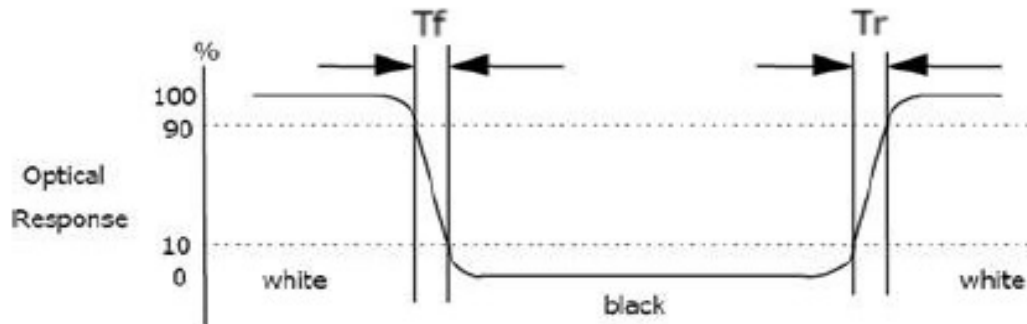

Figure 4. Response Time Testing





8. Reliability Test Items

No.	Test Item	Test Condition	Check Time
1	High temp storage	T=80°C	72Hrs
2	Low temp storage	T=-30°C	72Hrs
3	High temp operation	T=70°C	72Hrs
4	Low temp operation	T=-20°C	72Hrs
5	High temp & high humidity	T=50°C H=80%	72Hrs

Reliability Test Criteria:

Display function should be no change under normal operating condition.



9. Handling Precautions

9.1 Mounting Method

The panel of the LCM consists of two thin glasses with polarizer which easily get damaged. So extreme care should be taken when handling the LCM.

Excessive stress or pressure on the glass of the LCM should be avoided. Care must be taken to insure that no torsional or compressive forces are applied to the LCM unit when it is mounted.

If the customer's set presses the main parts of the LCM, the LCM may show the abnormal display. But this phenomenon does not mean the malfunction of the LCM and should be pressed by the way of mutual agreement.

To determine the optimum mounting angle, refer to the viewing angle range in the specification for each model.

Mount a LCM with the specified mounting parts. 9.1 Mounting Method

The panel of the LCM consists of two thin glasses with polarizer which easily get damaged. So extreme care should be taken when handling the LCM.

Excessive stress or pressure on the glass of the LCM should be avoided. Care must be taken to insure that no torsional or compressive forces are applied to the LCM unit when it is mounted.

If the customer's set presses the main parts of the LCM, the LCM may show the abnormal display. But this phenomenon does not mean the malfunction of the LCM and should be pressed by the way of mutual agreement.

To determine the optimum mounting angle, refer to the viewing angle range in the specification for each model.

Mount a LCM with the specified mounting parts..

9.2 Caution of LCM Handling and Cleaning

Since the LCM is made of glass, do not apply strong mechanical impact or static load onto it. Handling with care since shock, vibration, and careless handling may seriously affect the product.

If it falls from a high place or receives a strong shock, the glass maybe broken.

The polarizer on the surface of panel are made from organic substances. Be very careful for chemicals not to touch the polarizer or it leads the polarizer to be deteriorated.

If the use of a chemical is unavoidable, use soft cloth with solvent recommended below to clean the LCM's surface with wipe lightly.

-IPA (Isopropyl Alcohol), Ethyl Alcohol, Tri-chloro, tri-florothane.

Do not wipe the LCM's surface with dry or hard materials that will damage the polarizer and others. Do not use the following solvent—Water, acetone, Aromatics.

It is recommended that the LCM be handled with soft gloves during assembly, etc.

The polarizer on the LCM's surface are vulnerable to scratch and thus to be damaged by shape particles.



Do not drop water or any chemicals onto the LCM's surface.

A protective film is supplied on the LCM and should be left in place until the LCM is required for operation.

The ITO pad area needs special careful caution because it could be easily corroded. Do not contact the ITO pad area with HCFC, Soldering flux, Chlorine, Sulfur, saliva or fingerprint. To prevent from the ITO corrosion, customers are recommended that the ITO area would be covered by UV or silicon.

Please clean the LCD without ultrasonic to avoid line open.

9.3 Caution Against Static Charge

The LCM use C-MOS LSI drivers, so customers are recommended that any unused input terminal would be connected to Vdd or Vss, do not input any signals before power is turn on, and ground you body, work/assembly area, assembly equipments to protect against static electricity.

Remove the protective film slowly, keeping the removing direction approximate 30-degree not vertical from panel surface, if possible, under ESD control device like ion blower, and the humidity of working room should be kept over 50%RH to reduce the risk of static charge.

Avoid the use work clothing made of synthetic fibers. We recommend cotton clothing or other conductivity-treated fibers.

In handling the LCM, wear non-charged material gloves. And the conducting wrist to the earth and the conducting shoes to the earth are necessary.

9.4 Caution For Operation

It is indispensable to drive the LCM within the specified voltage limit since the higher voltage than the limit causes LCM's life shorter. An electro-chemical reaction due to DC causes undesirable deterioration of the LCM so that the use of DC drive should avoid.

Do not connect or disconnect the LCM to or from the system when power is on. Never use the LCM under abnormal conditions of high temperature and high humidity.

When expose to drastic fluctuation of temperature(hot to cold or cold to hot), the LCM may be affected; specifically, drastic temperature fluctuation from cold to hot, produces dew on the LCM's surface which may affect the operation of the polarizer on the LCM.

Response time will be extremely delay at lower temperature than the operating temperature range and on the other hand LCM may turn black at temperature above its operational range. However those phenomenon do not mean malfunction or out of order with the LCM. The LCM will revert to normal operation once the temperature returns to the recommended temperature range for normal operation.

Do not display the fixed pattern for a long time because it may develop image sticking due to the LCM structure. If the screen is displayed with fixed pattern, use a screen saver.

Do not disassemble and/or re-assemble LCM module



9.5 Packaging

Modules use LCM element, and must be treated as such.

- Avoid intense shock and falls from a height.
- To prevent modules from degradation, do not operate or store them exposed directly to sunshine or high temperature/humidity for long periods.

9.6 Storage

A slight dew depositing on terminals is a cause for electro-chemical reaction resulting in terminal open circuit. Relative humidity of the environment should therefore be kept below 60%RH.

Original protective film should be used on LCM's surface (polarizer). Adhesive type protective film should be avoided, because it may change color and/or properties of the polarizer.

Do not store the LCM near organic solvents or corrosive gasses.

Keep the LCM safe from vibration, shock and pressure.

Black or white air-bubbles may be produced if the LCM is stored for long time in the lower temperature or mechanical shocks are applied onto the LCM.

In the case of storing for a long period of time for the purpose or replacement use, the following ways are recommended.

- Store in a polyethylene bag with sealed so as not to enter fresh air outside in it.
- Store in a dark place where neither exposure to direct sunlight nor light is.
- Keep temperature in the specified storage temperature range.
- Store with no touch on polarizer surface by the anything else. If possible, store the LCM in the packaging situation when it was delivered.

9.7 Safety

For the crash damaged or unnecessary LCM, it is recommended to wash off liquid crystal by either of solvents such as acetone and ethanol and should be burned up later.

In the case of LCM is broken, watch out whether liquid crystal leaks out or not. If your hands touch the liquid crystal, wash your hands cleanly with water and soap as soon as possible.

If you should swallow the liquid crystal, first, wash your mouth thoroughly with water, then drink a lot of water and induce vomiting, and then, consult a physician.

If the liquid crystal get in your eyes, flush your eyes with running water for at least fifteen minutes.

If the liquid crystal touches your skin or clothes, remove it and wash the affected part of your skin or clothes with soap and running water.



10. QC

10.1 Purpose

To ensure the stability of our product and standardize our inspection

10.2 Application Range

This standard is applied to all 3.5 inch and smaller sized LCM product from Elsun Technology Co.Ltd

10.3 Definition of inspection area

C area: The area covered after installation

B area: visible area

A area: display area

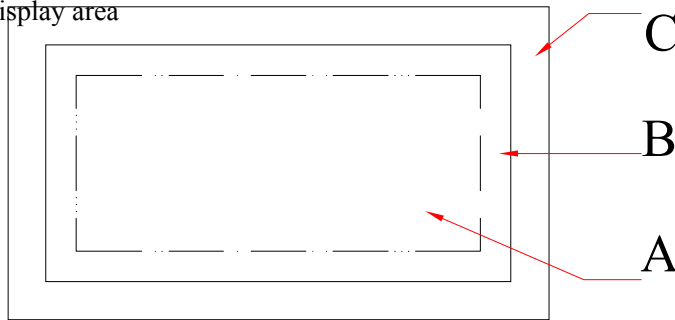

10.4 The environmental condition of inspection

Lighting conditions should be 20 ~ 40W fluorescent lamp (illumination at 1000 ± 200 lux)

Test ambient temperature should be 23 ± 5 °C, humidity at $50 \pm 20\%$ RH

The tested products should be placed 300mm away from the examiner's eye, and 30 degrees in the vertical direction observed within the region

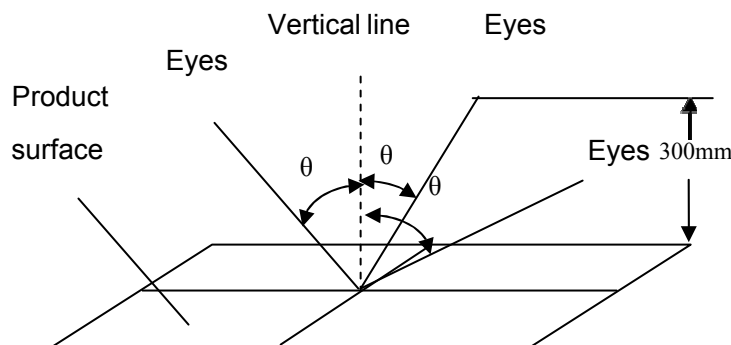

10.5 Identification

10.5.1 Bright dot: dots appearing bright and unchanged in size when the LCD panel is under black pattern.

10.5.2 Dark dot: dots appearing dark and unchanged size when the LCD panel is under RGBpicture.

10.6 Inspection items and criteria



10.6.1 Serious defect

No	inspection item	inspection criteria	defect grade
10.6.1.1	function failure	1) Non-display not allowed 2) Line missing not allowed 3) Invalid touch and drift not allowed (if need)	main defect
10.6.1.2	break	broken display not allowed	main defect
10.6.1.3	dimension	Dimension tolerance out of specified in the drawing not allowed.	main defect

10.6.2 Appearance defect

No	Inspection item	inspection criteria	defect grade
10.6.2.1	Dot defect black dot, white dot, dirt on surface, stain, bubble	1. dot defect identification:	Minor defect
		2. inspection criteria range	

$$\Phi = \frac{(\chi + \gamma)}{2}$$

Area and quantity dimension(mm)	quantity allowed		
	A area	B area	C area
$\Phi \leq 0.15$	ignore		ignore
$0.15 < \Phi \leq 0.2$	2 (spacing $\geq 10\text{mm}$)		
$0.2 < \Phi \leq 0.25$	1		
$\Phi > 0.25$	0		

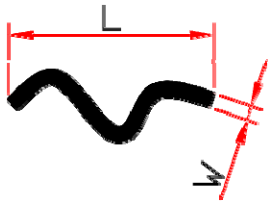

No	Inspection item	inspection criteria	defect grade			
10.6.2.2	line defect visible black/white line	1. identification of line dimension L: length W: width	Minor defect			
						
		2. inspection criteria				
		dimension(mm)		quantity allowed (total 3 pcs)		
		L (length)		W (width)	area	
		ignore		$W \leq 0.03$	A area B area C area	
		$L \leq 3.0$		$0.03 < W \leq 0.05$	ignore	
$L \leq 3.0$	$0.05 < W \leq 0.08$	2	ignore			
	$W > 0.08$	1				
		count according to dot defect				
10.6.2.3	scratch	1-If the scratch is visible after installation or at work, refer to 10.6.2.2 2-If the scratch is visible at special angel or at non-working status, refer to the following standards	Minor defect			
		dimension (mm)		Quantity allowed		
		L (length)		W (width)	area	
		ignore		$W \leq 0.03$	A B C	
		$5.0 < L \leq 10.0$		$0.03 < W \leq 0.05$	ignore	
		$L \leq 5.0$		$0.05 < W \leq 0.08$	2	ignore
				$W > 0.08$	1	
		Not allowed				

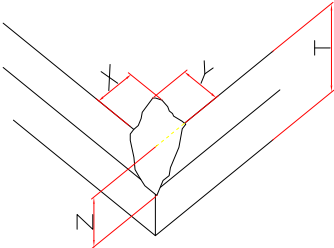
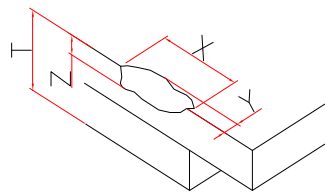
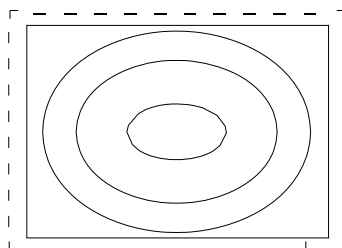
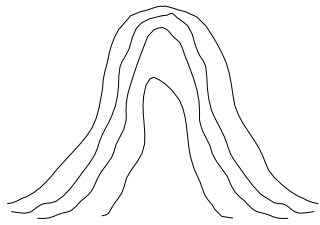

No	Inspection item	inspection criteria	defect grade
10.6.2.4	Glass defect	<p>1. broken angle</p> <p>X 不计 Y ≤ 2.0mm or X ≤ 2.0mm Y 不计 Meanwhile Z < T ignore</p>  <p>2. other broken part</p> <p>X ≤ 5.0mm Y ≤ 0.8mm Meanwhile Z ≤ T ignore</p> 	Minor defect
10.6.2.5	Newton ring	<p>1. regular Newton ring</p>  <p>① Newton ring area > 1/3 T/P area; not acceptable. ② Newton ring area ≤ 1/3 T/P area and doesn't affect the display result and no line distortion; acceptable</p> <p>2. Non-regular Newton ring</p>  <p>① Newton ring area > 1/2 T/P area, or no matter how big as long as it affects the display result; not acceptable Newton ring area ≤ 1/2 T/P area, and doesn't affect the display result and without line distortion; acceptable</p>	Minor defect



NO	Inspection item	inspection criteria	defect grade
10.6.2.6	FPC	<ol style="list-style-type: none"> 1. copper foil off, warping, crack and oxidation are not allowed 2. FPC crack, break, serious scratch and crease are not allowed 	main defect
		<ol style="list-style-type: none"> 3. if no special requirements, no release paper on double-sided adhesive FPC is not allowed. 4. Slight creases and scratches not exposed from the copper foil and with no affect to appearance and function are allowed. 5. if no special requirements, no insulating tape at welding part on backlight and touch-screen is notallowed.. 6. Parts off, breakage and deform are not allowed. 7. print on the surface should be clear and correct. 	Minor defect
10.6.2.7	basic appearance requirements	<ol style="list-style-type: none"> 1. clean appearance, no dirt, fingerprints and other traces. 2. ITO circuit on COG coating area should not be exposed. 3. Rust, sever scratch, deformation, obvious burrs and color dirt are not allowed. 4. Mis-assembly, part missing are notallowed. 5. Bubble caused by mis-pasted polaroid refers to 10.6.2.1 6. For watermark, the criteria is upon agreed by bothparties. 	Minor defect



10.6.3 electric defect

No	Inspection item	inspection criteria	defect grade
10.6.3.1	picture defect	Non-display, more or less image and display defect are not allowed.	main defect
10.6.3.2	bright/dark line	Not allowed.	main defect
10.6.3.3	display dot defect	<ol style="list-style-type: none"> 1. one dot is acceptable. 2. Under bright status, 2 dark dots with more than 5mm distance is allowed. 3. Totally 2 bright or dark dots are acceptable. 4. The other defect under bright status refers to 10.6.2.1 <p>Note: Electric bright/dark dot means one pixel; less than 1/2 of 1 pixel can be ignored.</p>	Minor defect
10.6.3.4	connected dot/line defect	<ol style="list-style-type: none"> 1. Two continuous defect pixel connected dots are not allowed. 2. Line defect refers to 10.6.2.2 	Minor defect
10.6.3.5	wrong view direction	Wrong view directions, such as opposite view angle, are not allowed.	main defect
10.6.3.6	back light defect	<ol style="list-style-type: none"> 1. Backlight off are not allowed. 2. Uneven light, dead light, flicker light, dark angle, light leakage are not allowed. 3. Brightness should comply with drawing 	main defect

end.