



CUSTOMER APPROVAL SHEET

Company Name

MODEL PV13904PY24G-C1

CUSTOMER

Title : _____

Name : _____

APPROVED

- APPROVAL FOR SPECIFICATIONS ONLY (Spec. Ver.)
- APPROVAL FOR SPECIFICATIONS AND ES SAMPLE (Spec. Ver.)
- APPROVAL FOR SPECIFICATIONS AND CS SAMPLE (Spec. Ver. V00)
- CUSTOMER REMARK :



Contents

A. General Specification	4
1. Physical Specifications	4
2. FPC Pin Assignment	5
3. Absolute Maximum Ratings	6
B. DC Characteristics	6
C. AC Characteristics	9
D. Optical Specifications	13
E. Reliability Test Items	16
F. Outline Dimension	17
G. Inpection standards	18



A. General Specification

1. Physical Specifications Description

Parameter	Value	Unit
Screen Size	1.39"	-
Display Mode	AMOLED	-
Color Depth	16.7M	-
Display Resolution	454RGB*454	pixels
Module Size	42(H)*42.6(W)*2.227(T)(Exclude FPC)	mm
Active Area (A.A)	35.41(H)*35.41(W)	mm
Pixel Arrangement	Real R.G.B Arrangement	-
Viewing Direction	All	
LCD Controller/Driver	RM69330	-
IC Package Type	COF	-
Interface	MIPI/SPI	-
CTP Controller/Driver	TMA525B	-
Power Supply Voltage	3.3	V
LCM Brightness	350	cd /m ²



2. FPC Pin Assignment

2.1 Main FPC Pin assignment — AMOLED Panel Input/Output Signal Interface

FPCA recommended connector: YXT-BB1F-24P-02

Main board recommended connector: YXT-BB1F-24S-02

FPC	Pin_name	I/O	
1	XRES	I	Device reset signal (0 : enable ; 1 : Disable)
2	VCI_EN	I	VCI enable signal
3	VPP	-	OTP
4	GND	Po	Ground
5	TE	O	Synchronous signal output from panel to avoid tearing effect
6	DSI_D0N	I/O	MIPI data negative signal
7	AM_SPI_CSX	I	SPI interface
8	DSI_D0P	I/O	MIPI data positive signal
9	AM_SPI_SCL	I	SPI interface
10	GND	Po	Ground
11	AM_SPI_DCX	I	SPI interface
12	DSI_CLKN	I	MIPI strobe negative signal
13	AM_SPI_SDI	I/O	SPI interface
14	DSI_CLKP	I	MIPI strobe positive signal
15	AM_SPI_SDO	I/O	SPI interface
16	GND	Po	Ground
17	ID(H)	-	ID pin
18	VDDIO	Po	Power supply for interface system except MIPI
19	VBAT	Po	AMOLED power
20	VDDIO	Po	Power supply for interface system except MIPI
21	VBAT	Po	AMOLED power
22	VBAT	Po	AMOLED power
23	VBAT	Po	AMOLED power
24	VBAT	Po	AMOLED power

Note: I = input ; O = output ; Po = Power ; I/O = input / Output;



2.2 CTP Input/Output Signal Interface

FPC	Pin_name	I/O	
1	VCC(2V8)	P	Power supply for CTP: 2.8~3.3V
2	SCL(1V8)	I	CTP I2C clock input pin.
3	SDA(1V8)	I/O	CTP I2C data input/output pin.
4	EINT(1V8)	O	Interrupt request to the host
5	RST(1V8)	I	Reset pin for CTP.
6	GND	P	System ground.

3. Absolute Maximum Ratings

Item	Symbol	Min.	Max.	Unit	Remark
Digital Power Supply	VDDIO	-0.3	5.5	V	
Analog Power Supply	VCI	-0.3	5.5	V	
Operating temperature	Top	-20	60	V	
Storage temperature	Tstg	-30	70	V	

Note : If the module exceeds the absolute maximum ratings, it may be damaged permanently.

B. DC Characteristics

1. Electrical Characteristics

1.1 Power Characteristic:

Item	Symbol	Min.	Typ.	Max.	Unit	Remark
Battery power Voltage	Vbat	2.9	3.7	4.8	V	-
Digital Power supply	VDDIO	1.65	1.8	1.95	V	Ref

1) Normal Mode

Power Supply: VDDIO=1.8V Vbat=3.7V

Frame Frequency: $F_{frame}=60\text{HZ}$ @ 25degC, Brightness 450 nits, Command Mode

Display Condition	Symbol	Min.	Typ.	Max.	Unit	Remark
100% Pixel On 450nits	Normal mode	-	252	291	mW	Ref

2) Idle Mode

Power Supply: VDDIO=1.8V Vbat=3.7V

Frame Frequency: $F_{frame}=15\text{HZ}$ @ 25degC, Brightness 30 nits, Command Mode

Display Condition	Symbol	Min.	Typ.	Max.	Unit	Remark
10% Pixel On,30nits	Idle mode	-	12	15	mW	Ref



3) Deep Standby Mode

Display Condition	Symbol	Min.	Typ.	Max.	Unit	Remark
All Pixel Off, 0nits/ Vci off/Vddio on	Standby mode	-	-	10	μW	-

2. Initial CODE

1. Power On Sequence				
W/R	Type	Register	Parameter	Description
				Turn on VCI
				Delay (No Limit)
				Turn on VDDIO
				Delay (No Limit)
				Turn on VBAT
				Delay >10ms
				Reset pin high
				Delay >10ms
				MIPI初始化
				Delay >1ms
w	0x15	0xFE	0x07	
w	0x15	0x15	0x04	SRAM Read adjust control
w	0x15	0xFE	0x00	User Command
w	0x15	0x35	0x00	enable TE
w	0x15	0x3A	0x75	用于调整16bit rgb
w	0x15	0x51	0xFF	
w	0x15	0x2A	0x00	
w			0x0E	
w			0x01	
w			0xD3	
w	0x15	0x2B	0x00	
w			0x00	
w			0x01	
w			0xC5	
w	0x05	0x11		sleep out
				Delay >120ms
w	0x05	0x29		display on



3. Graphic memory writing direction

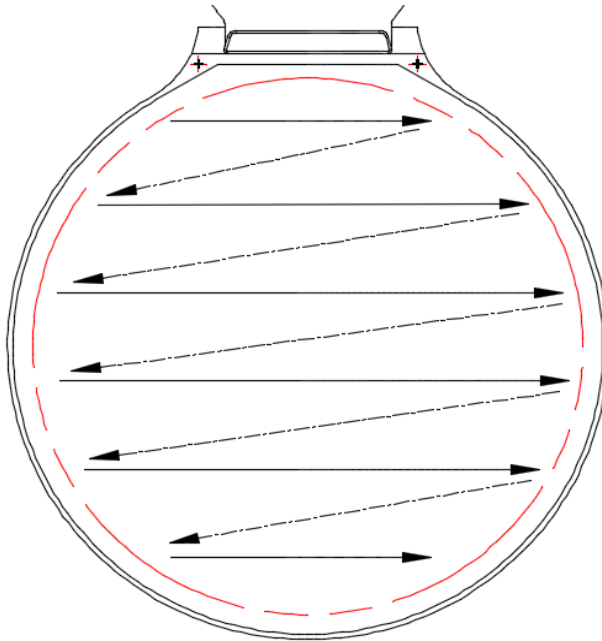

4. Recommended Operating Sequence

4.1 Power on sequence

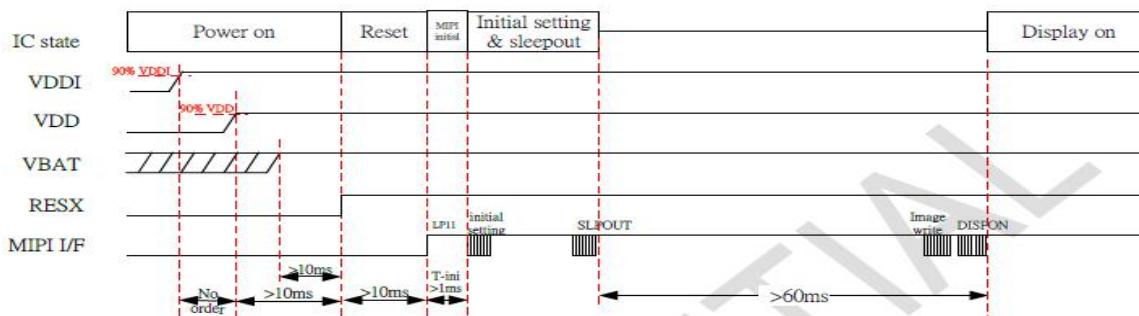

4.2 Power off sequence





C. AC Characteristics (MIPI)

1. HS Data Transmission Burst

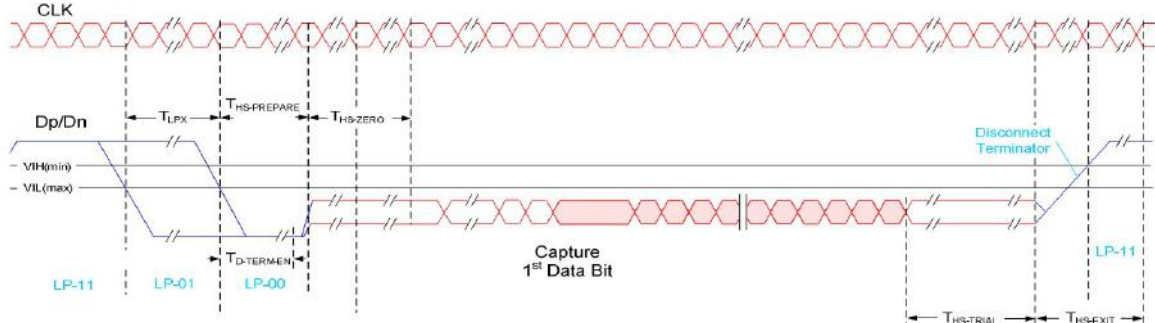

2. HS Data Transmission Burst

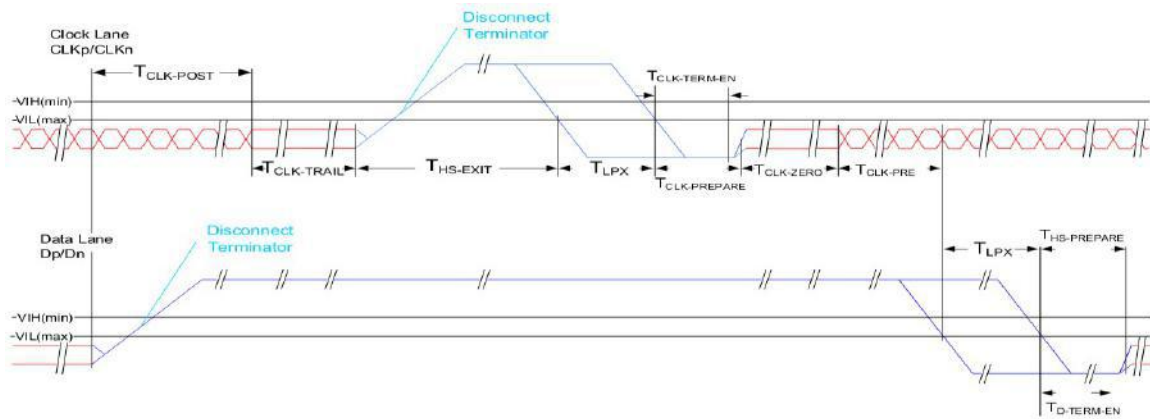

3. Turnaround Procedure

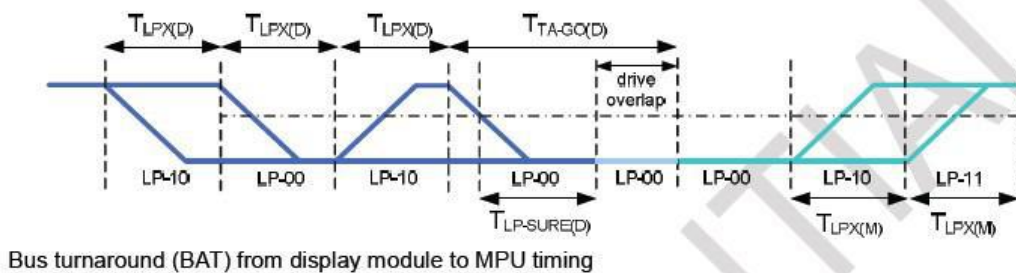
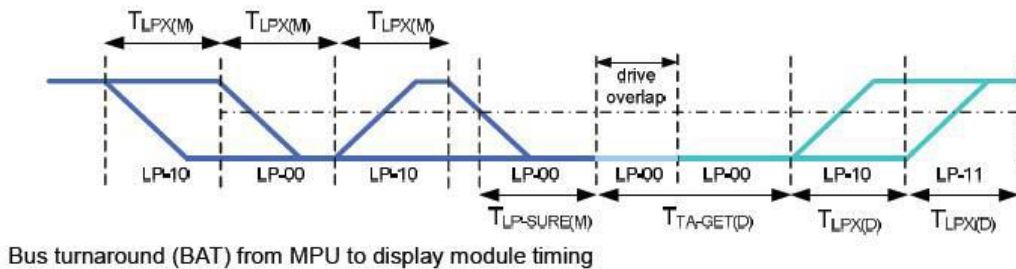



4. Timing Parameters

Symbol	Description	Min	Typ	Max	Unit
TREOT	30%-85% rise time and fall time	-	-	35	ns
TCLK-MISS	Timeout for receiver to detect absence of Clock transitions and disable the Clock Lane HS-RX.	-	-	60	ns
TCLK-POST*1	Time that the transmitter continues to send HS clock after the last associated Data Lane has transitioned to LP Mode. Interval is defined as the period from the end of THS-TRAIL to the beginning of TCLK-TRAIL.	60ns + 52*UI (For DCS)	-	-	ns
TCLK-PRE	Time that the HS clock shall be driven by the transmitter prior to any associated Data Lane beginning the transition from LP to HS mode.	8	-	-	ns
TCLK-SETTLE	Time interval during which the HS receiver shall ignore any Clock Lane HS transitions, starting from the beginning of TCLK-PRE.	95	-	300	ns
TCLK-TERM-EN	Time for the Clock Lane receiver to enable the HS line termination, starting from the time point when Dn crosses VIL,MAX.	Time for Dn to reach VTERM-EN		38	ns



THS-SETTLE	Time interval during which the HS receiver shall ignore any Data Lane HS transitions, starting from the beginning of THSPREPARE.	85 ns + 6*UI		145 ns + 10*UI	ns
TEOT	Time from start of THS-TRAIL or TCLK-TRAIL period to start of LP-11 state	-	-	105ns+48*UI	ns
THS-EXIT(1)	time to drive LP-11 after HS burst	100	-	-	ns
THS-PREPARE	Time to drive LP-00 to prepare for HS transmission	40ns + 4*UI	-	85ns+6*UI	ns
THS-PREPARE + THS-ZERO	THS-PREPARE + Time to drive HS-0 before the Sync sequence	145ns + 10*UI	-	-	ns
THS-SKIP	Time-out at RX to ignore transition period of EoT	40	-	55ns+4*UI	ns
THS-TRAIL	Time to drive flipped differential state after last payload data bit of a HS transmission burst	60 + 4*UI	-	-	ns
TLPX	Length of any Low-Power state period	50	-	-	ns
Ratio TLPX	Ratio of TLPX(MASTER)/TLPS(SLA VE) between Master and Slave side	2/3	-	3/2	ns
TTA-GET	Time to drive LP-00 by new TX	5*TLPX	5*TLPX	5*TLPX	ns
TTA-GO	Time to drive LP-00 after Turnaround Request	4*TLPX	4*TLPX	4*TLPX	ns
TTA-SURE	Time-out before new TX side starts driving	TLPX	-	2*TLPX	ns



5. Timing requirements for RESETB

When RESETB of the reset pin equals to Low, it will be in the condition of reset. When it is in the condition of reset, it will make the device recover the initial set. However, in order to avoid the reset noise cause reset, there is a mechanism to judge about whether the reset is needed or not.

The closed interval of Low can be shown as the following.

(Test condition: VDDIO=1.65V~3.6V, VSS=0V, TA=-20°C~+70°C)

Parameter	Symbol	Conditions	Spec			Unit
			Min.	Typ	Max.	

Table: Reset timing



Figure: Reset timing



D. Optical Specifications

Test condition: IOVCC=1.8V , VCI=2.8V , Ta=25°C

Item	Symbol	Condition	Value			Unit	Note	
			Min	Typ	Max			
Luminance		$\theta=0^\circ$	300	350	-	cd/m ²	Note 1	
Uniformity		$\Phi=0^\circ$	80	85	-	%	Note 2	
Viewing Angle	Left	θ_L	Cr≥200	80	85	-	Deg.	Note 3
	Right	θ_R		80	85	-		
	Top	ψ_T		80	85	-		
	Bottom	ψ_B		80	85	-		
Contrast Ratio	CR	$\theta=0^\circ$	10000	100000	-	-	Note 4	
Response Time	Tr+Tf	$\Phi=0^\circ$	-	2	3	ms	Note 5	
Color Coordinate of CIE1931	Red	X	$\theta=0^\circ$ $\Phi=0^\circ$	-	-	-	-	-
		Y		-	-	-		
	Green	X		-	-	-		
		Y		-	-	-		
	Blue	X		-	-	-		
		Y		-	-	-		
	White	X		0.29	0.32	0.35		
		Y		0.3	0.33	0.36		
NTSC Ratio	NTSC	CIE1931		103	-	%	-	
Flicker	-	-	-	-	-30	dB	-	
Gamma	-	-	1.9	2.2	2.5		Note 6	
Crosstalk	ΔCT	-	-	-	1.1		Note 7	



Note 1: Luminance measurement

The test condition is measured on the surface of AMOLED module at 25°C.

- Measurement equipment CS2000 or similar equipment (Field of view:1deg,Distance:50cm)
- Measuring surroundings: Dark room.
- Measuring temperature: Ta=25°C.
- Adjust operating voltage to get optimum contrast at the center of the display.

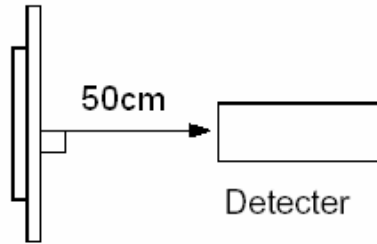

Note 2: Uniformity

The luminance uniformity is calculated by using following formula:

$$\Delta Bp = Bp (\text{Min.}) / Bp (\text{Max.}) \times 100 (\%)$$

$Bp (\text{Max.}) = \text{Maximum brightness in 5 measured spots}$

$Bp (\text{Min.}) = \text{Minimum brightness in 5 measured spots.}$

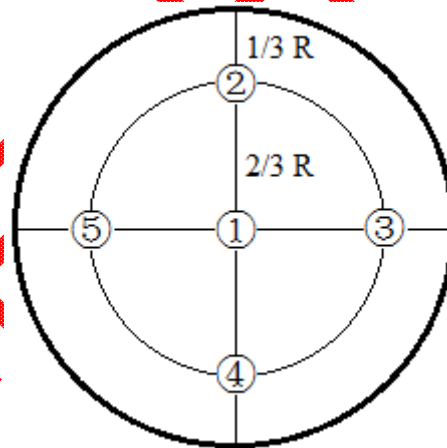

Note 3: The definition of Viewing Angle

Refer to the graph below marked by θ and ϕ

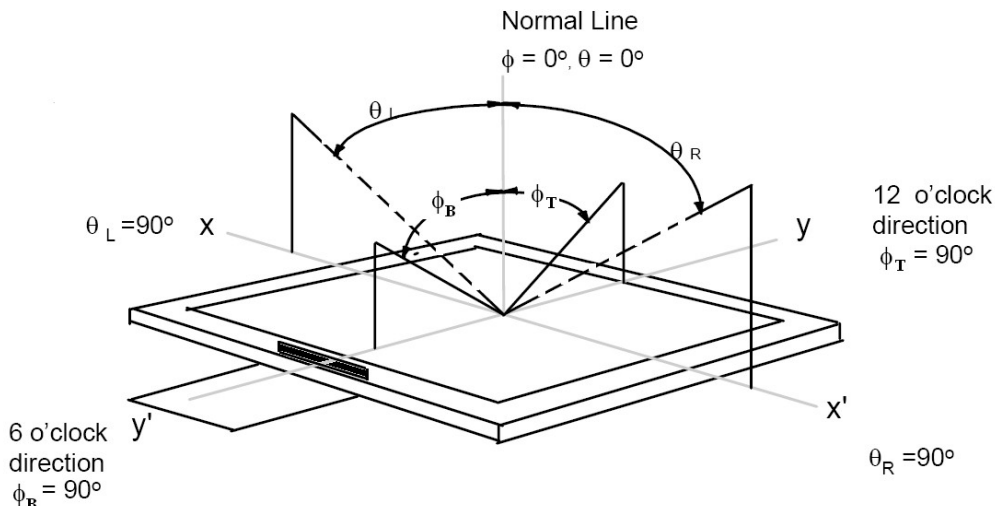

Note 4: The definition of Contrast Ratio:



$$\text{Contrast Ratio (CR)} = \frac{\text{Luminance When AMOLED is at "White" state}}{\text{Luminance When AMOLED is at "Black" state}}$$

Note 5: Definition of Response time.

The output signals of photo detector are measured when the input signals are changed from "black" to "white" (Voltage falling time) and from "white" to "black" (Voltage rising time), respectively. The response time is defined as the time interval between the 10% and 90% of amplitudes. Refer to figure as below.

Note 6: Gamma curve

The whole curve's tolerance must control within +/-0.3, test the gray scale below:

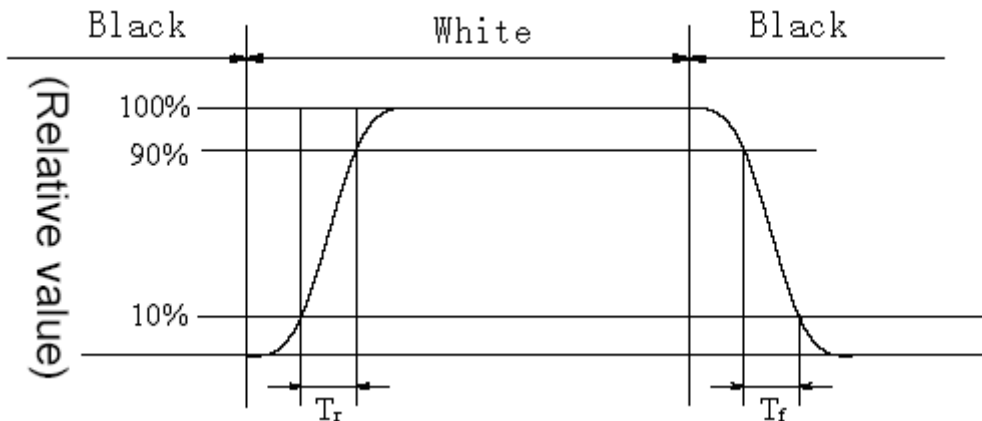

8, 16, 25, 33, 41, 49, 58, 66, 74, 82, 90, 99, 107, 115, 123, 132, 140, 148, 156, 165, 173, 181, 189, 197, 206, 214, 222, 230, 239, 255

Note 7: Crosstalk

There should be no visible cross-talk in normal direction of the display when the two "Cross-talk Test Patterns" below are loaded.

ΔBp (Max.) = Maximum value in $\Delta Bp1 \sim \Delta Bp4$.

ΔBp (Min.) = Minimum value in $\Delta Bp1 \sim \Delta Bp4$.

$\Delta CT = \Delta Bp$ (Max.) / ΔBp (Min.).

ΔCT must be less than 1.10

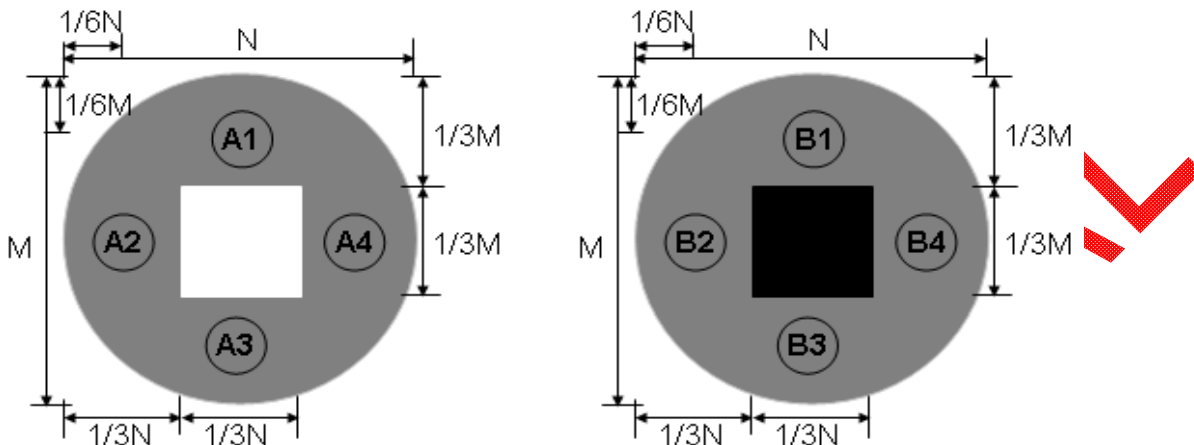

Cross-talk Test Pattern

FIELD



E. Reliability Test Items

Category	No.	Test items	Conditions	Remark
Reliability (Environment)	1	High Temp. Operation	Ta= 60°C 72 hrs	Reliability (Environment)
	2	High Temp. Storage	Ta= 70 °C 72 hrs	
	3	Low Temp. Operation	Ta= -20 °C 72 hrs	
	4	Low Temp. Storage	Ta= -30 °C 72 hrs	
	5	High Temp./Humi. Operation	Ta= 50 °C. 90% RH 72hrs	
	6	Thermal Shock	-30 °C ~70 °C, Dwell for 30 min. 30 cycles.	Non-operation

Judge Criteria: No functional defect.



F. Outline Dimension

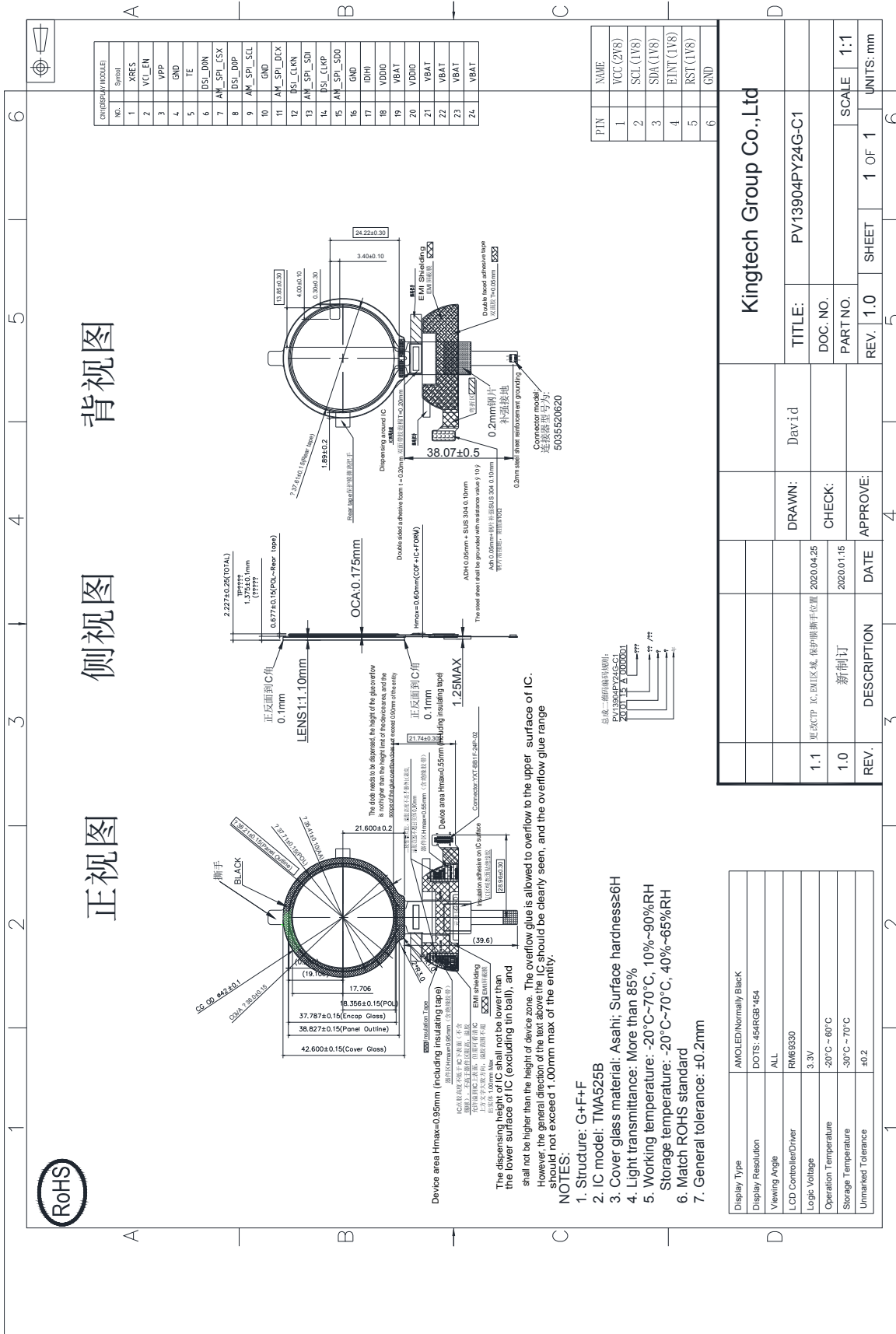



G. Inpection standards

1.Purpose:

To make a rule of the inspection TFT display module. To guarantee the quality of TFT display module.

2.Application:

For project-- PV13904PY24G-C1

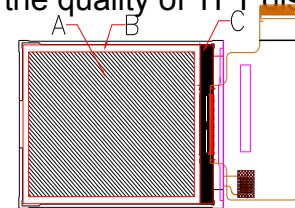

3.Definition :

A zone is display area, B zone is visible area, C zone is invisible area, D zone is FPC area.

4.Device needed

Testing jig, Model machine, Sample, film.

5.General inspect condition :

5.1.Under 20 W~40 W lamp light, distance between your eyes and the module is 30 cm±5 cm Keep the width 45°between your eye up and down, left and right in the vertical way. Please refer to the picture below :

5.2 . Measure unit is (mm) if no special indicate.

6.Sampling plan& Permit standard :

6.1.Normal inspect MIL-STD-105E II

6.2.Accept standard:Critical defect(CR):0, Major defect (MA):0.4, minor defect:1.5,Total defect:1.5

6.3.Definition of defec :

Defect Type	Definition
Critical defect (CR)	The defect which may damage user's life or property. Or make the product to be useless.
Major defect (MA)	Which will affect the display function, or seriously appearance defect, or makes the product cannot meet customers' expectation.
Minor defect (MI)	The defects which do not impact product's function but a little damage on appearance.



7、Inspect Standard :

7.1. Function electrical inspect standard :

No.	Inspect item	Judgment	Defect level	Judge method															
1	Display Status	Nothing display, Black, White screen, continuously unusual	Critical	By visual															
		Uneven display, color depth not the same, damaged photo, messy code, unstable, lined, shows abnormal display, lack of display, wrong visual direction, static line, dot or line appear when switch	Major defect																
		The display color according to the sample of quality department.	Minor defect																
2	Backlight	LED visible, different color, unstable lighting, the light too high or too low, seriously leak light (according to customers' product to decide whether inspect this item or not) damaged light.	Major defect	Constant current and limited voltage															
		Backlight current beyond the standard, seriously color temperature unusual																	
		Offend to eyes, slightly LED visible(compare to sample), interference wave (compare to sample), water wave	Minor defect	By visual															
		Brightness uniformity and color temperature (refer to sample's standard)	Minor defect																
3	Black dot, white/spark dot, pin hole(including visible polaroid bubble,	<table border="1" style="width: 100%;"> <thead> <tr> <th>Pic</th> <th>Diameter (Φ)</th> <th>Acceptance</th> </tr> </thead> <tbody> <tr> <td></td> <td>$\Phi \le 0.1$</td> <td>Ignor</td> </tr> <tr> <td></td> <td>$0.15 < \Phi \le 0.25$</td> <td>2</td> </tr> <tr> <td></td> <td>$\Phi > 0.25$</td> <td>NG</td> </tr> <tr> <td colspan="3">Remark : $\Phi = (X+Y) / 2$</td> </tr> </tbody> </table>	Pic	Diameter (Φ)	Acceptance		$\Phi \le 0.1$	Ignor		$0.15 < \Phi \le 0.25$	2		$\Phi > 0.25$	NG	Remark : $\Phi = (X+Y) / 2$			Minor defect	By visual
		Pic	Diameter (Φ)	Acceptance															
			$\Phi \le 0.1$	Ignor															
			$0.15 < \Phi \le 0.25$	2															
			$\Phi > 0.25$	NG															
Remark : $\Phi = (X+Y) / 2$																			
1 piece color dot/dark dot is acceptable, connect dot is not allowed.																			
1. 1. Max 2 dot defect is acceptable, and the space																			



	backlight dirty) color dot,dark dot, connect dot	<p>between two dots should exceed 10mm, 1 spark dot is allowed, smaller than 0.1 can be ignored, allying dot is not allowed.</p> <p>2. If the white and black dot is obvious, please refer to reference sample.</p> <p>3.Reverse black/white refer to biggest visible area.</p> <p>4.Max 3 Φ0.25mm is allowed in B zone, in C zone, everything is allowed except bubble</p>																
4	Black line, white line (include under electronic measurement visible polarizer scratch, polarizer fur)	<table border="1" data-bbox="327 555 1045 750"> <thead> <tr> <th colspan="2">Size</th> <th rowspan="2">Accept quantity</th> </tr> <tr> <th>L</th> <th>W</th> </tr> </thead> <tbody> <tr> <td>ignore</td> <td>$W < 0.05$</td> <td>ignore</td> </tr> <tr> <td>$L \leq 10$</td> <td>$0.05 \leq W \leq 0.1$</td> <td>2</td> </tr> <tr> <td>ignore</td> <td>$W > 0.1$</td> <td>Depends on dot</td> </tr> </tbody> </table> <p>Remark :</p> <p>1. Black/white line defect should not exceed 2pcs,and pitch should exceed 10mm.</p> <p>2. If the line defect is obviously, please refer to limited sample.</p>	Size		Accept quantity	L	W	ignore	$W < 0.05$	ignore	$L \leq 10$	$0.05 \leq W \leq 0.1$	2	ignore	$W > 0.1$	Depends on dot	Minor defect	By visual, film card
Size		Accept quantity																
L	W																	
ignore	$W < 0.05$	ignore																
$L \leq 10$	$0.05 \leq W \leq 0.1$	2																
ignore	$W > 0.1$	Depends on dot																

7.2. Visual inspection standard :

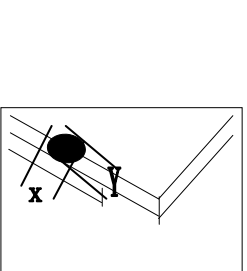
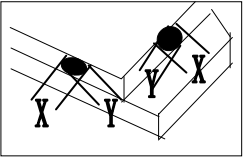
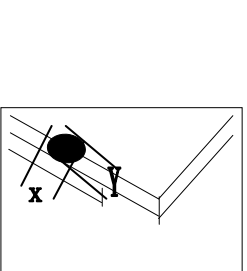
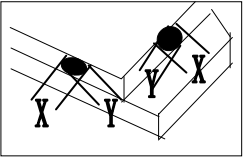
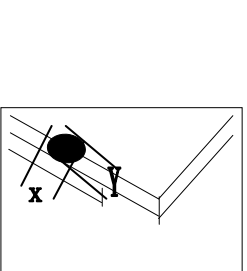
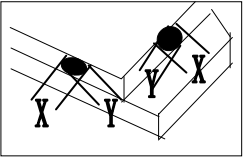
No.	Item	Inspect Standard	Defect Level	Method												
1	Crack	<p>A.Normal Crack</p> <table border="1" data-bbox="327 1227 1037 1579"> <thead> <tr> <th>Pic</th> <th>X</th> <th>Y</th> <th>Z</th> </tr> </thead> <tbody> <tr> <td></td> <td>Ignore</td> <td>≤ 2.0</td> <td>$\leq 1/2t$</td> </tr> <tr> <td></td> <td>$\leq 1/8 X$ Landscape length</td> <td>Cannot be seen in visible area</td> <td>$\leq t$</td> </tr> </tbody> </table> <p>Remark :</p> <p>1. t=thickness single glass</p> <p>2. X=length ; Y=width; Z=depth All those crack should not appear in visible area and should not course the frame glue exposure 1/3 area.</p>	Pic	X	Y	Z		Ignore	≤ 2.0	$\leq 1/2t$		$\leq 1/8 X$ Landscape length	Cannot be seen in visible area	$\leq t$	Minor defect	By visual, Ocular, film card
Pic	X	Y	Z													
	Ignore	≤ 2.0	$\leq 1/2t$													
	$\leq 1/8 X$ Landscape length	Cannot be seen in visible area	$\leq t$													



		<p>B. Back of Pin and Front ITO part of Pin</p> <table border="1"> <thead> <tr> <th>Pic.</th> <th>Part</th> <th>X</th> <th>Y</th> <th>Z</th> </tr> </thead> <tbody> <tr> <td></td> <td>Back of Pin</td> <td>ignore</td> <td>$\leq 1/3L$</td> <td>$\leq 1/2t$</td> </tr> <tr> <td></td> <td>Front of Pin</td> <td>≤ 2</td> <td>$\leq 1/3L$</td> <td>$\leq t$</td> </tr> </tbody> </table> <p>Remark: Damage area except the ITO part the space between the nearest ITO lead should exceed the width of pin, or depends on the damage ITO pin standard.</p>	Pic.	Part	X	Y	Z		Back of Pin	ignore	$\leq 1/3L$	$\leq 1/2t$		Front of Pin	≤ 2	$\leq 1/3L$	$\leq t$	Minor defect	By visual, Ocular, film card
Pic.	Part	X	Y	Z															
	Back of Pin	ignore	$\leq 1/3L$	$\leq 1/2t$															
	Front of Pin	≤ 2	$\leq 1/3L$	$\leq t$															
		<p>C. ITO</p> <table border="1"> <thead> <tr> <th>Pic.</th> <th>X</th> <th>Y</th> <th>Z</th> </tr> </thead> <tbody> <tr> <td></td> <td>$\leq 1/3$ ITO</td> <td>$\leq 1/3 t$</td> <td>$\leq 1/2t$</td> </tr> </tbody> </table>	Pic.	X	Y	Z		$\leq 1/3$ ITO	$\leq 1/3 t$	$\leq 1/2t$	Minor defect	By visual, Ocular, film card							
Pic.	X	Y	Z																
	$\leq 1/3$ ITO	$\leq 1/3 t$	$\leq 1/2t$																
No.	Item	Standard	Defect level	Method															
1	Crack	<p>D. Conner crack</p> <table border="1"> <thead> <tr> <th>Pic.</th> <th>X</th> <th>Y</th> <th>Z</th> </tr> </thead> <tbody> <tr> <td></td> <td>≤ 2</td> <td>≤ 1.5</td> <td>$\leq t$</td> </tr> </tbody> </table> <p>Remark: If the broken position is close to ITO, it's regarded as ITO crack.</p>	Pic.	X	Y	Z		≤ 2	≤ 1.5	$\leq t$	Minor defect	By visual, Ocular, film card							
		Pic.	X	Y	Z														
	≤ 2	≤ 1.5	$\leq t$																
<p>E. Crack or full screen crack</p> <table border="1"> <thead> <tr> <th>Pic</th> <th>Standard</th> </tr> </thead> <tbody> <tr> <td></td> <td>Crack or full screen crack</td> </tr> </tbody> </table>	Pic	Standard		Crack or full screen crack	Major defect	By visual													
Pic	Standard																		
	Crack or full screen crack																		

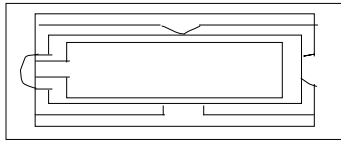

2	Frame glue defect	 <p>Remark : 1.frame glue narrow and dirty, bubble exceed 1/3 frame width. 2.glue move into A zone</p>	Minor defect	By visual, Ocular, film card
3	Iron Frame	Seriously deform ,defect, wrong material	Major defect	By visual, Ocular, film card
		Burr, sharp angle, dirty, surface broken, rust.	Minor defect	

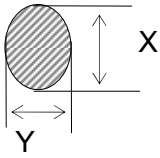
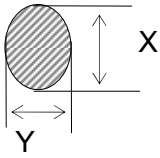
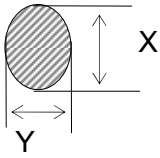
NO.	Item	Stadard	Level	Method												
4	Size	Out-line size and special requested size do not conform to the drawing; product's structure do not conform to the drawing	Major defect	Caliper gauge												
		Normal size	Minor defect													
5	Black dot, white/spark dot, polarizer bubble(A.B zone), backlight dirty) dot	<table border="1" data-bbox="347 1518 986 1832"> <thead> <tr> <th>Pic</th> <th>Φ 值</th> <th>Accept</th> </tr> </thead> <tbody> <tr> <td rowspan="4">  </td> <td>$\Phi \leq 0.10$</td> <td>ignore</td> </tr> <tr> <td>$0.10 < \Phi \leq 0.25$</td> <td>2</td> </tr> <tr> <td>$\Phi > 0.25$</td> <td>NG</td> </tr> <tr> <td colspan="2" style="text-align: center;">$\Phi = (X+Y) / 2$</td> </tr> </tbody> </table> <p>Only accept 2 dots,and the dots distance should be 10mm≥.</p>	Pic	Φ 值	Accept		$\Phi \leq 0.10$	ignore	$0.10 < \Phi \leq 0.25$	2	$\Phi > 0.25$	NG	$\Phi = (X+Y) / 2$		Minor defect	By visual, Ocularr, film card
Pic	Φ 值	Accept														
	$\Phi \leq 0.10$	ignore														
	$0.10 < \Phi \leq 0.25$	2														
	$\Phi > 0.25$	NG														
	$\Phi = (X+Y) / 2$															



	defect(scratch, knock) do not under electronic measurement																			
6	Scratch, black line, fur, fiber	<table border="1"> <tr> <th>Pic.</th> <th>Width</th> <th>Length</th> <th>Approved Qty</th> </tr> <tr> <td rowspan="2"></td> <td>$W < 0.05 \text{ mm}$</td> <td>$L \leq 10 \text{ mm}$</td> <td>Ignore</td> </tr> <tr> <td>$0.05 \leq W \leq 0.1$</td> <td>$L \leq 10$</td> <td>2</td> </tr> <tr> <td></td> <td>$W > 0.1$</td> <td colspan="2">Refer to dot standard</td> </tr> </table>	Pic.	Width	Length	Approved Qty		$W < 0.05 \text{ mm}$	$L \leq 10 \text{ mm}$	Ignore	$0.05 \leq W \leq 0.1$	$L \leq 10$	2		$W > 0.1$	Refer to dot standard			Minor defect	By visual
Pic.	Width	Length	Approved Qty																	
	$W < 0.05 \text{ mm}$	$L \leq 10 \text{ mm}$	Ignore																	
	$0.05 \leq W \leq 0.1$	$L \leq 10$	2																	
	$W > 0.1$	Refer to dot standard																		
7	Polarizer	Wrong paste angle/polarizer model/type/thickness			Major defect	By visual														
		Polarizer edge broken, curly, bubble(refer to standard)paste inclined, hinder the frame			Minor defect															
8	Protect film	<ol style="list-style-type: none"> Protect film broken,curly,dirty, scratch, damage, curly Protect film fall off or hard to tear 			Minor defect	By visual														
9	IC Crack	<table border="1"> <tr> <th>Pic.</th> <th>Standard</th> </tr> <tr> <td rowspan="4"> </td> <td>$IC \Phi \leq 0.5 \text{ mm}$</td> </tr> <tr> <td>Electronic property is Ok</td> </tr> <tr> <td>no crack</td> </tr> <tr> <td>Approved if the above inspect pass</td> </tr> </table>	Pic.	Standard		$IC \Phi \leq 0.5 \text{ mm}$	Electronic property is Ok	no crack	Approved if the above inspect pass		Minor defect	Microscope								
Pic.	Standard																			
	$IC \Phi \leq 0.5 \text{ mm}$																			
	Electronic property is Ok																			
	no crack																			
	Approved if the above inspect pass																			

No.	Item	Standard	Level	Method
-----	------	----------	-------	--------





10	FPC	Size do not conform to the drawing; bad cut of PFC; serious tear and scratch of FPC; serious oxidation of golden finger; wrong quantity., fake solder	Major defect	By visual
		<ol style="list-style-type: none"> Slight scratch Oxidation, glue tin, welding dot overtop, backlight/touch panel off position Surface dirty, no insulation paste or paste curly/serious off position 	Minor defect	
11	Silica gel	Appointed silica gel unused(if requested)	Major defect	By visual
		<ol style="list-style-type: none"> The height of gel exceed polarizer height or paste on The height of gel exceed polarizer height or paste on CF ; Gel overflow, pore 	Minor defect	
12	Gummed paper	<ol style="list-style-type: none"> Stickiness must be good, perk, skew, wrinkle, tear, fall over. Color, size, paste position should conform to the drawing 	Minor defect	By visual
13	Assemble	Wrong assemble, device overlap, seriously off position,	Major defect	By visual
		Other staff assembled in, improper clip, improper assemble	Minor defect	
14	Leak	Unapproved	Major defect	By visual
15	Code	Wrong code	Major defect	By visual
		Wrong script or script size, unclear	Minor	



script/defect. Wrong code position

defect

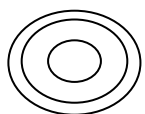
7.3.Touch panel inspect:

No.	Item	Standard			Level	Method
1	Dot defect	Dot diameter	Judge	Remark	Minor defect	By visual
		$\Phi \leq 0.1$	Ignore	2 defect is allowed and space between these two should exceed 10mm.		
		$0.10 < \Phi \leq 0.25$	2			
		$0.25 < \Phi$	NG			
2	Line defect	Refer to option 6 in 7.2			Minor defect	By visual
3	Crack	Refer to option1 in 7.2				
4	Kink mark on surface	Unapproved			Major defect	By visual
5	Newton ring/interference line	Item	Specs.	Pic.	Minor defect	By visual towards light
		Newton ring	$\leq 5\text{mm}$ and not obvious, 1 is allowed			
		Interference line	$\leq 1/4$ touch panel inspect area and slight, is allowed			



6	Heave of touch panel	<p>Heave under 0.3mm is approved</p>	Minor defect	By Ocular
7	Abnormal of touch panel	No function reaction, or abnormal reaction	Major defect	By visual
8	Pull tape	Bad stickiness or no pull tape	Minor defect	By visual
9	Double side glue	No fall over the glue	Minor defect	By visual

10	Drop line	Defect	NG	Major defect
	Broken line	Defect		
	No function	Defect		
	Line drawing defect	Defect		
	Signal channel defect	Defect		

7.3.2 Touch panel Extra Inspection

Item	Standard	Judge	
		Pass	Defect level
Dirty or dust on the surface	Finger print,water print,or something can not be removed.	NG	
Touch panel bonding out of position	Expose the film or silver line to be seen in VA	NG	Major Defect
	Bonding size can not match approval drawing	NG	Major Defect

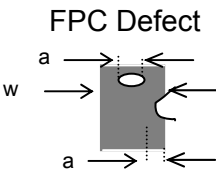

Deckle edge	Remove	NG	Minor Defect
IC Bonding out of position	FPC PIN foot and silver paste bonding $\leq 1/3$ is acceptable. FPC PIN position up and down depends on whether the FPC position is right.	NG	Minor Defect
Camera hole/IR hole protector	1)Complete cover Camera hole/IR hole 2)Dirty/Dot/Scratch are not allowed 3)Bonding position match drawing	NG	Minor Defect
<p>FPC Defect</p>  <p>Print ink</p>	Cave,hole $a \leq w/3$	NG	Accept
	Open circuit	NG	NG
	Oxidation,Pollute,Deformation	NG	NG
	CTP edge exposed or whole line expose backlight is not allowed	NG	Minor Defect
	Ink hole $D \leq 0.1$ mm	Ignore	Minor Defect
	Ink hole $0.1 \text{ mm} < D \leq 0.25 \text{ mm}$	distance > 10 mm	Minor Defect

7.4. Inspection standard of package :

No.	Item	Standard	Level	Method
1	Quantity model	Wrong quantity in tray, quantity do not meet the outer box signed number, wrong model	Major defect	By visual
2	Set-out the inner box	No turn over /back turn/overlap, no wrong Tray. product package meet the request and put in order	Major defect	By visual
3	Out-in box	No broken or mildew on out –in box, stable sealed, clean and tidy look	Major defect	By visual