



PRODUCT SPECIFICATIONS

For Customer: _____

: APPROVAL FOR SPECIFICATION

Customer Model No. _____

: APPROVAL FOR SAMPLE

Module No.: PV035012H0554M

Date : 2022-11-25

Table of Contents

No.	Item	Page
1	Cover Sheet(Table of Contents)	
2	Revision Record	
3	General Specifications	
4	Outline Drawing	
5	Absolute Maximum Ratings	
6	Electrical Specifications	
7	Optical Characteristics	
8	Reliability Test Items and Criteria	
9	Precautions for Use of LCD Modules	

For Customer's Acceptance:

Approved By	Comment

PREPARED	CHECKED	VERIFIED BY QA DEPT	VERIFIED BY R&D DEPT



2. Revision Record

Date	Rev.No.	Page	Revision Items	Prepared
2022-11-25	V0		The first release	YZD



3. General Specifications

PV035012H0554M is a TFT-LCD module. It is composed of a TFT-LCD panel, driver IC, FPC, a backlight unit. The 3.5'' display area contains 320X240 pixels and can display up to 16.7M colors. This product accords with RoHS environmental criterion.

Item	Contents	Unit	Note
LCD Type	TFT	-	
Display color	16.7M		
Viewing Direction	12 O' clock	O'Clock	
Operating temperature	-20~+70	°C	
Storage temperature	-30~+80	°C	
Module size	Refer to outline drawing	mm	
Active Area(W×H)	70.08X52.56	mm	
Number of Dots	320x240	dots	
Controller	HX8238D	-	
Power Supply Voltage	3.3	V	
Outline Dimensions	Refer to outline drawing	-	
Backlight	6-LEDs (white)	pcs	
Weight	---	g	
Interface	RGB	-	

Note 1: Color tune is slightly changed by temperature and driving voltage.

Note 2: Without FPC and Solder.



4. Outline Drawing

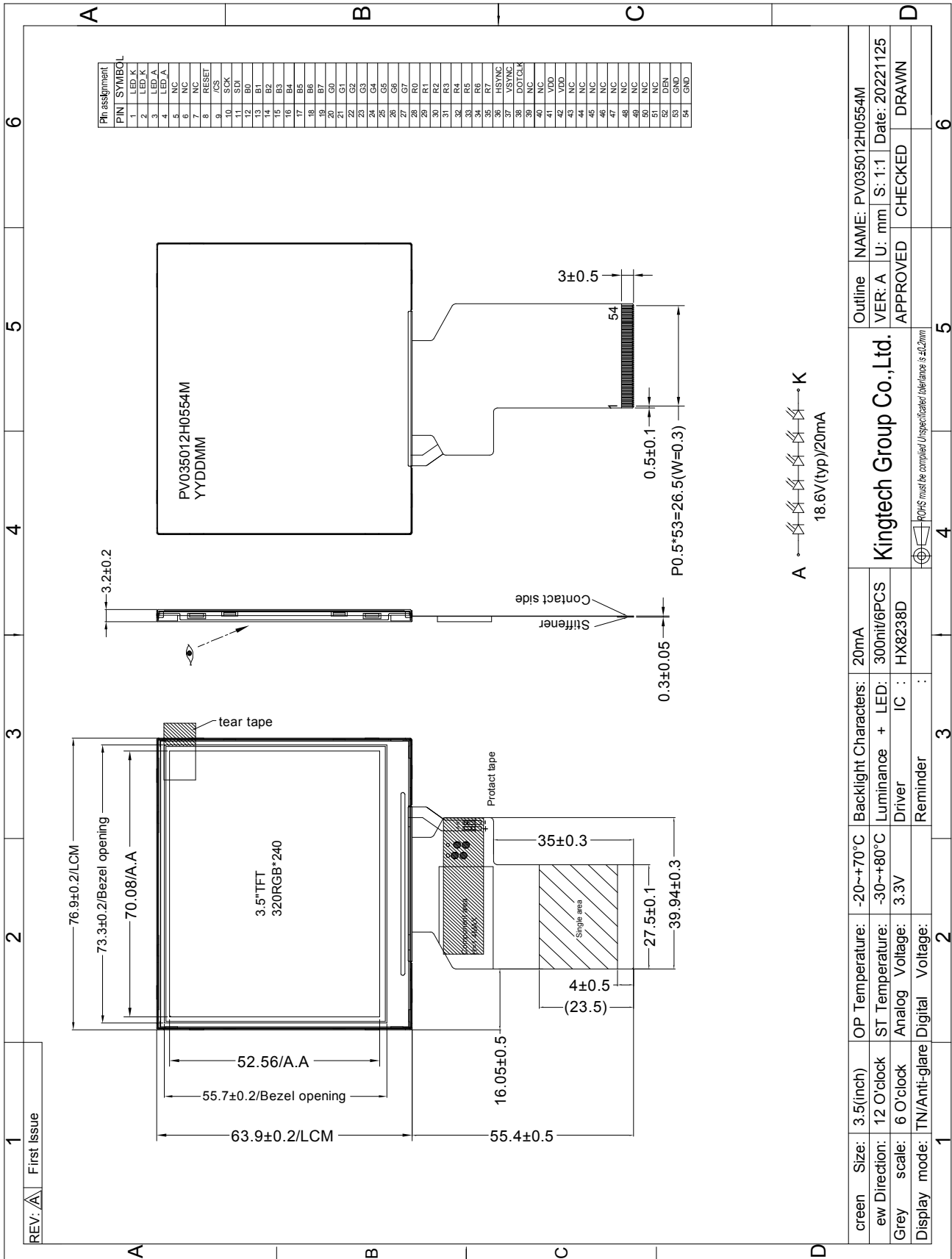



5. Absolute Maximum Ratings(Ta=25°C)

5.1 Electrical Absolute Maximum Ratings.(Vss=0V ,Ta=25°C)

Item	Symbol	Min.	Max.	Unit	Note
Power Supply Voltage	V _{CC}	-0.3	4.0	V	1, 2

Notes:

1. If the module is above these absolute maximum ratings. It may become permanently damaged. Using the module within the following electrical characteristic conditions are also exceeded, the module will malfunction and cause poor reliability.
2. V_{CC}>GND must be maintained.
3. Please be sure users are grounded when handing LCD Module

5.2 Environmental Absolute Maximum Ratings.

Item	Storage		Operating		Note
	MIN.	MAX.	MIN.	MAX.	
Ambient Temperature	-30°C	80°C	-20°C	70°C	1,2
Humidity	-	-	-	-	3

1. The response time will become lower when operated at low temperature.
2. Background color changes slightly depending on ambient temperature.
The phenomenon is reversible.
3. Ta<=40°C:90%RH MAX.
Ta>=40°C:Absolute humidity must be lower than the humidity of 90%RH at 40°C.



6. Electrical Specifications

6.1 Electrical characteristics(V_{SS}=0V ,Ta=25°C)

Parameter	Symbol	Condition	Min	Typ	Max	Unit	Note	
Power supply	V _{CC}	Ta=25°C	3.0	3.3	3.6	V		
Input voltage	'H'	V _{IH}	V _{CC} =3.3V	0.8V _{CC}	-	V _{CC}	V	
	'L'	V _{IL}	V _{CC} =3.3V	0	-	0.2V _{CC}	V	
Current Consumption	I _{CC1}	Normal mode	-	TBD	-	mA	1	
	I _{CC2}	Sleep mode	-	TBD	-	mA	1	

Note:

1: Tested in 1×1 chessboard pattern.

6.2 LED backlight specification(V_{SS}=0V ,Ta=25°C)

Item	Symbol	Condition	Min	Typ	Max	Unit	Note
Supply voltage	V _f	I _f =20mA	-	18.6	-	V	
Uniformity	Δ Bp	I _f =20mA	80			%	

Note:

1 : The "LED Life time" is defined as the module brightness decrease to 50% original brightness at T=25°C and I_{LED} =20mA. The LED Life time could be decreased if operating I_{LED} is larger than 20mA



6.3 Interface signals

Pin No.	Symbol	I/O	Function
1-2	LED-	P	LED power cathode
3-4	LED+	P	LED power anode
5	YU(NC)	O	Touch panel control pin(NC)
6	XR(NC)	O	Touch panel control pin(NC)
7	NC	-	No connection
8	RESET	I	Reset pin
9	SPENA	I	SPI interface data enable signal
10	SPCLK	I	SPI interface clock
11	SPDAT	I	SPI interface data
12-19	B0-B7	I	Blue data bus
20-27	G0-G7	I	Green data bus
28-35	R0-R7	I	Red data bus
36	HSYNC	I	Horizontal sync input
37	VSYNC	I	Vertical sync input
38	DCLK	I	Data clock input
39-40	NC	-	No connection
41-42	VCC	P	System power
43	YD(NC)	O	Touch panel control pin(NC)
44	XL(NC)	O	Touch panel control pin(NC)
45-51	NC	-	No connection
52	DE	I	Data enable pin
53-54	GND	P	Ground



6.4 SYNC-DE Mode

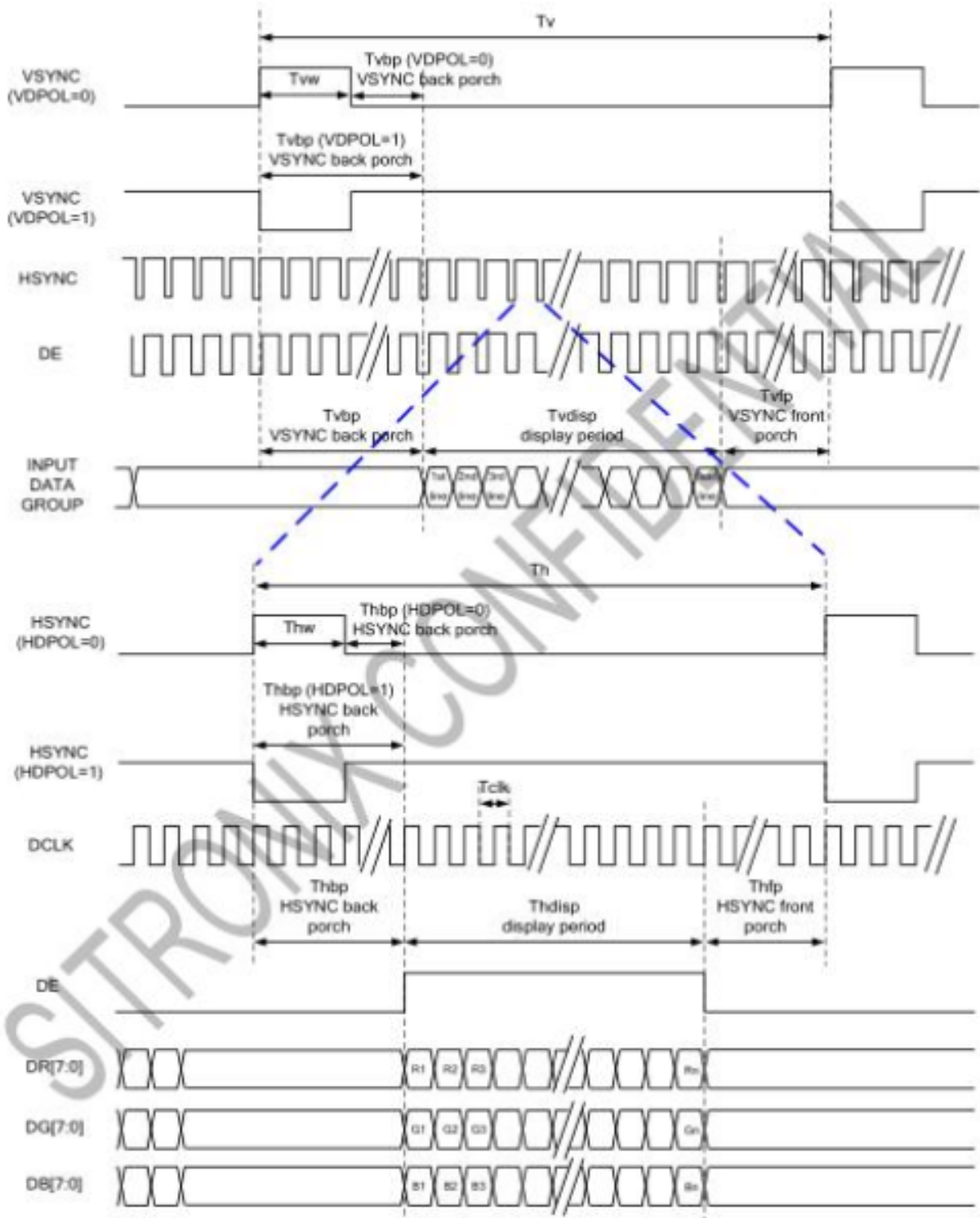



6.5 Parallel 24bit RGB Input Timing Table

Parallel 24-bit RGB Input Timing Table							
Item	Symbol	Min.	Typ.	Max.	Unit	Note	
DCLK Frequency	Fclk	5	6	8	MHz		
DCLK Period	Tclk	125	167	200	ns		
HSYNC	Period Time	Th	325	371	438	DCLK	
	Display Period	Thdisp		320		DCLK	
	Back Porch	Thbp	3	43	43	DCLK	SYNC mode back porch control by H_BLANKING[7:0] setting Thbp= H_BLANKING[7:0]
	Front Porch	Thfp	2	8	75	DCLK	
	Pulse Width	Thw	2	4	43	DCLK	
VSYNC	Period Time	Tv	244	260	289	HSYNC	
	Display Period	Tvdisp		240		HSYNC	
	Back Porch	Tvbp	2	12	12	HSYNC	SYNC mode back porch control by V_BLANKING[7:0] setting Tvbp= V_BLANKING[7:0]
	Front Porch	Tvfp	2	8	37	HSYNC	
	Pulse Width	Tvw	2	4	12	HSYNC	

6.6 Serial 8bit RGB Input Timing Table

Serial 8-bit RGB Input Timing Table							
Item	Symbol	Min.	Typ.	Max.	Unit	Remark	
DCLK Frequency	Fclk	15	18	21	MHz		
DCLK Period	Tclk	47	55	66	ns		
HSYNC	Period Time	Th	965	1011	1078	DCLK	
	Display Period	Thdisp		960		DCLK	
	Back Porch	Thbp	3	43	43	DCLK	SYNC mode back porch control by H_BLANKING[7:0] setting Thbp= H_BLANKING[7:0]
	Front Porch	Thfp	2	8	75	DCLK	
	Pulse Width	Thw	2	4	43	DCLK	
VSYNC	Period Time	Tv	244	260	289	HSYNC	
	Display Period	Tvdisp		240		HSYNC	
	Back Porch	Tvbp	2	12	12	HSYNC	SYNC mode back porch control by V_BLANKING[7:0] setting Tvbp= V_BLANKING[7:0]
	Front Porch	Tvfp	2	8	37	HSYNC	
	Pulse Width	Tvw	2	4	12	HSYNC	



7. Optical Characteristics

Item	Symbol	Condition	Min.	Typ.	Max.	Unit	Note		
Brightness	Bp	$\theta=0^\circ$	-	300	-	Cd/m ²	1		
Uniformity	Δ Bp	$\Phi=0^\circ$	80	-	-	%	1,2		
Viewing Angle	3:00	Cr \geq 10	-	65	-	Deg	3		
	6:00		-	65	-				
	9:00		-	55	-				
	12:00		-	65	-				
Contrast Ratio	Cr	$\theta=0^\circ$ $\Phi=0^\circ$	300	350	-	-	4		
Response Time	T _r +T _f		-	25	-	ms	5		
Color of CIE Coordinate	W	x	$\theta=0^\circ$ $\Phi=0^\circ$	-	TBD	-	-	1,6	
		y		-	TBD	-	-		
	R	x		-	TBD	-	-		
		y		-	TBD	-	-		
	G	x		-	TBD	-	-		
		y		-	TBD	-	-		
	B	x		-	TBD	-	-		
		y		-	TBD	-	-		
NTSC Ratio	S		55	60	-	%			

Note: The parameter is slightly changed by temperature, driving voltage and material

Note 1: The data are measured after LEDs are turned on for 5 minutes. LCM displays full white. The brightness is the average value of 9 measured spots. Measurement equipment PR-705 (Φ8mm)

Measuring condition:

- Measuring surroundings: Dark room.
- Measuring temperature: Ta=25 °C.
- Adjust operating voltage to get optimum contrast at the center of the display.

Measured value at the center point of LCD panel after more than 5 minutes while backlight turning on.

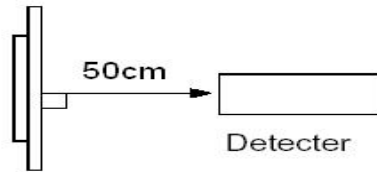

Note 2: The luminance uniformity is calculated by using following formula.

$$\Delta B_p = B_p (\text{Min.}) / B_p (\text{Max.}) \times 100 (\%)$$

$B_p (\text{Max.})$ = Maximum brightness in 9 measured spots

$B_p (\text{Min.})$ = Minimum brightness in 9 measured spots.

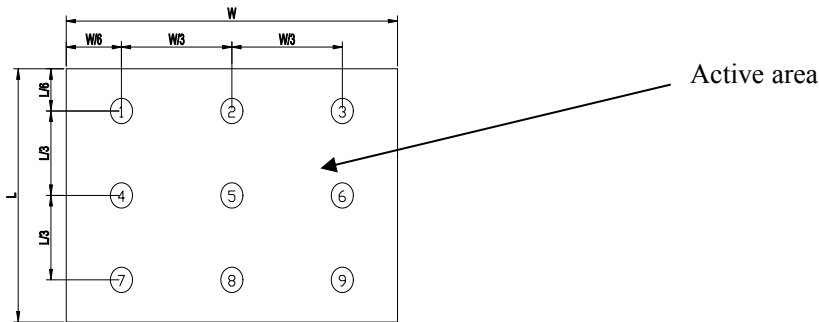

Note 3: The definition of viewing angle:

Refer to the graph below marked by ϑ and ϕ

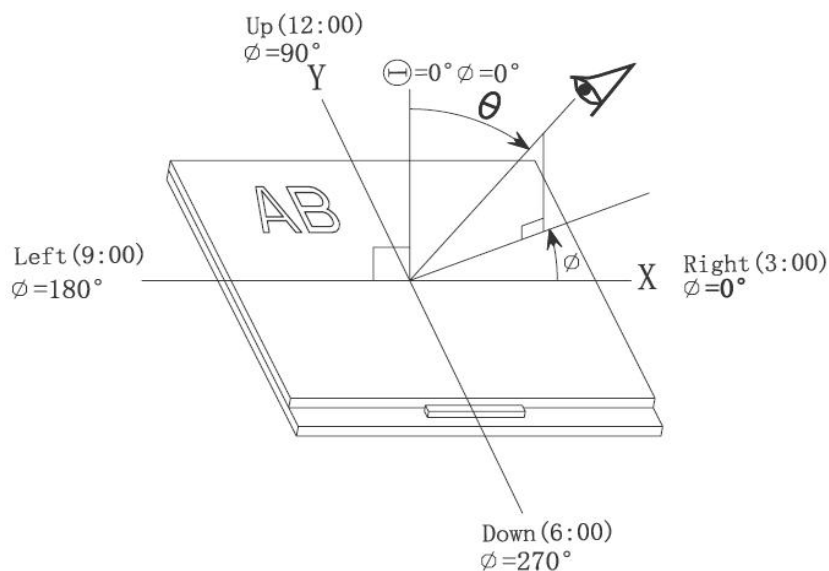

Note 4: Definition of contrast ratio. (Test LCD using DMS501)

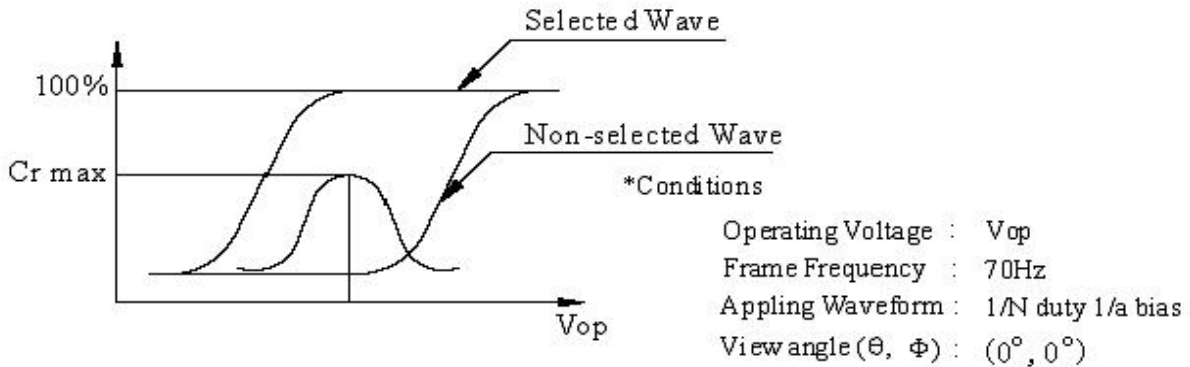

$$\text{Contrast ratio}(Cr) = \frac{\text{Brightness of selected dots}}{\text{Brightness of non-selected dots}}$$

Note 5: Definition of Response time. (Test LCD using DMS501):

The output signals of photo detector are measured when the input signals are changed from "black" to "white"(falling time) and from "white" to "black"(rising time), respectively. The response time is defined as the time interval between the 10% and 90% of amplitudes. Refer to figure as below.

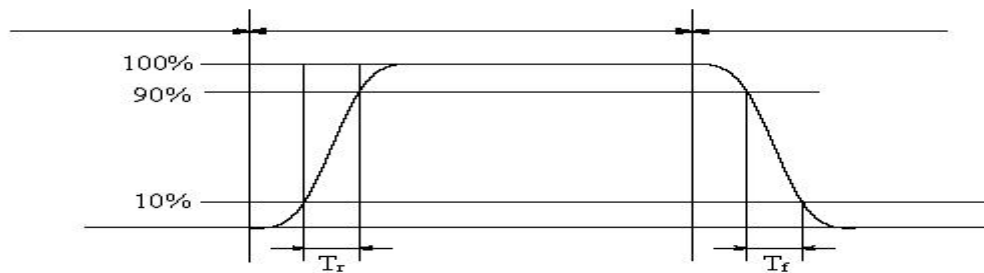

The definition of response time

Note 6: Definition of Color of CIE Coordinate and NTSC Ratio.

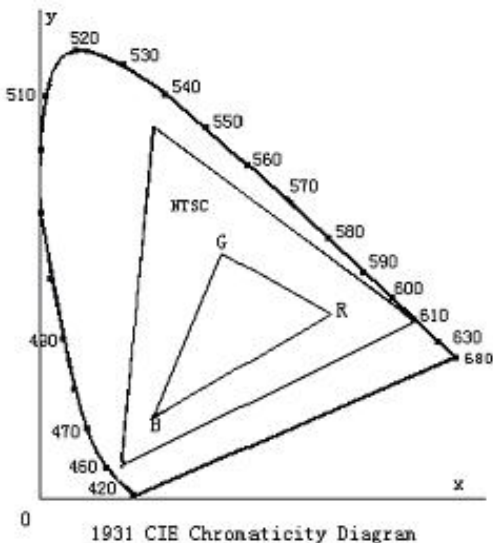

Color gamut:

$$S = \frac{\text{area of RGB triangle}}{\text{area of NTSC triangle}} \times 100\%$$

Note 7: Definition of cross talk.

$$\text{Cross talk ratio}(\%) = \frac{|\text{pattern A Brightness} - \text{pattern B Brightness}|}{\text{pattern A Brightness}} \times 100$$

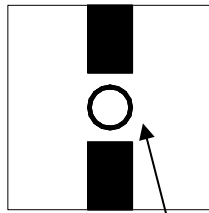

Pattern A

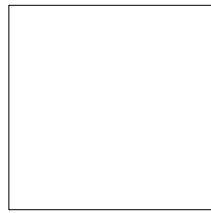

Pattern B

Measurement point(center)

Electric volume value=3F+/-3Hex



8. Reliability Test Items and Criteria

No	Test Item	Test condition	Criterion
1	High Temperature Storage	80°C±2°C 96H Restore 2H at 25°C Power off	1. After testing, cosmetic and electrical defects should not happen. 2. Total current consumption should not be more than twice of initial value.
2	Low Temperature Storage	-30°C±2°C 96H Restore 2H at 25°C Power off	
3	High Temperature Operation	70°C±2°C 96H Restore 2H at 25°C Power on	
4	Low Temperature Operation	-20°C±2°C 96H Restore 4H at 25°C Power on	
5	High Temperature/Humidity Storage	60°C±2°C 90%RH 96H Power off	
6	Temperature Cycle	-30°C ———— 80°C after 5 cycle, Restore 2H at 25°C 30min 5min 30min Power off	
7	Vibration Test	10Hz~150Hz, 100m/s ² , 120min	Not allowed cosmetic and electrical defects.
8	Shock Test	Half- sine wave, 300m/s ² , 11ms	
9	ESD test	Voltage: ±4kv R: 200Ω C: 150pF Air/Contact discharge, each 10time	

Note: Operation: Supply 3.3V for logic system.

The inspection terms after reliability test, as below

ITEM	Inspection
Contrast	CR>50%
IDD	IDD<200%
Brightness	Brightness>60%
Color Tone	Color Tone+/-0,05



9. Precautions for Use of LCD Modules

9.1 Handling Precautions

- 9.1.1 *The display panel is made of glass. Do not subject it to a mechanical shock by dropping it from a high place, etc.*
- 9.1.2 *If the display panel is damaged and the liquid crystal substance inside it leaks out, be sure not to get any in your mouth, if the substance comes into contact with your skin or clothes, promptly wash it off using soap and water.*
- 9.1.3 *Do not apply excessive force to the display surface or the adjoining areas since this may cause the color tone to vary.*
- 9.1.4 *The polarizer covering the display surface of the LCD module is soft and easily scratched. Handle this polarizer carefully.*
- 9.1.5 *If the display surface is contaminated, breathe on the surface and gently wipe it with a soft dry cloth. If still not completely clear, moisten cloth with one of the following solvents:*
- Isopropyl alcohol
 - Ethyl alcohol
- Solvents other than those mentioned above may damage the polarizer. Especially, do not use the following:*
- Water
 - Ketone
 - Aromatic solvents
- 9.1.6 *Do not attempt to disassemble the LCD Module.*
- 9.1.7 *If the logic circuit power is off, do not apply the input signals.*
- 9.1.8 *To prevent destruction of the elements by static electricity, be careful to maintain an optimum work environment.*
- a. *Be sure to ground the body when handling the LCD Modules.*
 - b. *Tools required for assembly, such as soldering irons, must be properly ground.*
 - c. *To reduce the amount of static electricity generated, do not conduct assembly and other work under dry conditions.*
 - d. *The LCD Module is coated with a film to protect the display surface. Be care when peeling off this protective film since static electricity may be generated.*



9.2 Storage precautions

9.2.1 *When storing the LCD modules, avoid exposure to direct sunlight or to the light of fluorescent lamps.*

9.2.2 *The LCD modules should be stored under the storage temperature range. If the LCD modules will be stored for a long time, the recommend condition is:*

Temperature : 0 °C ~ 40 °C

Relatively humidity: ≤80%

9.2.3 *The LCD modules should be stored in the room without acid, alkali and harmful gas.*

9.3 *The LCD modules should be no falling and violent shocking during transportation, and also should avoid excessive press, water, damp and sunshine.*

END